

CSI - Ohio

The Common Sense Initiative

Business Impact Analysis

Agency Name: Ohio Board of Building Standards

Regulation/Package Title: Ohio Building Code Update

Rule Number(s): Rescind all existing rules in 4101:1; Adopt new rules 4101:1-1-01, 4101:1-2-01, 4101:1-3-01, 4101:1-4-01, 4101:1-5-01, 4101:1-6-01, 4101:1-7-01, 4101:1-8-01, 4101:1-9-01, 4101:1-10-01, 4101:1-11-01, 4101:1-12-01, 4101:1-13-01, 4101:1-14-01, 4101:1-15-01, 4101:1-16-01, 4101:1-17-01, 4101:1-18-01, 4101:1-19-01, 4101:1-20-01, 4101:1-21-01, 4101:1-22-01, 4101:1-23-01, 4101:1-24-01, 4101:1-25-01, 4101:1-26-01, 4101:1-27-01, 4101:1-28-01, 4101:1-29-01, 4101:1-30-01, 4101:1-31-01, 4101:1-32-01, 4101:1-33-01, 4101:1-34-01, 4101:1-35-01; and adopt new rule 4101:7-7-01

Date: January 3, 2017

Rule Type:

New

Amended

5-Year Review

Rescinded

The Common Sense Initiative was established by Executive Order 2011-01K and placed within the Office of the Lieutenant Governor. Under the CSI Initiative, agencies should balance the critical objectives of all regulations with the costs of compliance by the regulated parties. Agencies should promote transparency, consistency, predictability, and flexibility in regulatory activities. Agencies should prioritize compliance over punishment, and to that end, should utilize plain language in the development of regulations.

Regulatory Intent

77 SOUTH HIGH STREET | 30TH FLOOR | COLUMBUS, OHIO 43215-6117

CSIOhio@governor.ohio.gov

1. Please briefly describe the draft regulation in plain language.

Please include the key provisions of the regulation as well as any proposed amendments.

The Ohio Board of Building Standards (Board) proposes to rescind all existing rules in 4101:1 and adopt new Ohio Administrative Code (OAC) rules as follows:

4101:1-1-01 This proposed rule regulates the administration of the building code by certified building departments and the steps an owner needs to take to obtain a plan approval or “permit” to build and inspections.

4101:1-2-01 This proposed rule sets forth the definitions of terms used in rules 4101:1-1 through 4101:1-35-01.

4101:1-3-01 This proposed rule classifies buildings based on the purpose for which they are used.

4101:1-4-01 This proposed rule supplements the code for special uses and occupancies and may alter requirements found elsewhere.

4101:1-5-01 This proposed rule regulates the minimum type of construction of a building, including allowable height and area, mezzanines, unlimited area structures, and mixed occupancies.

4101:1-6-01 This proposed rule classifies buildings in one of five (I-V) types of construction.

4101:1-7-01 This proposed rule sets forth the requirements for fire-resistance-rated construction.

4101:1-8-01 This proposed rule regulates the performance requirements for interior finishes to control the spread of fire.

4101:1-9-01 This proposed rule sets forth the requirements for active fire safety provisions.

4101:1-10-01 This proposed rule regulates the design of the means of egress of buildings for the protection of occupants.

4101:1-11-01 This proposed rule regulates the accessibility of buildings for people with physical disabilities.

4101:1-12-01 This proposed rule sets forth the requirements for the interior environment of buildings intended for human occupancy.

4101:1-13-01 This proposed rule regulates the energy efficiency of buildings by reference to the International Energy Conservation Code and ASHRAE 90.1 Standard.

4101:1-14-01 This proposed rule provides requirements for the materials and construction of exterior surfaces.

4101:1-15-01 This proposed rule regulates the materials, design and construction of roofs.

4101:1-16-01 This proposed rule prescribes the structural loading requirements for design and construction of buildings.

4101:1-17-01 This proposed rule regulates special inspections structural observations and load testing.

77 SOUTH HIGH STREET | 30TH FLOOR | COLUMBUS, OHIO 43215-6117

CSIOhio@governor.ohio.gov

4101:1-18-01 This proposed rule regulates the design and construction of building foundations.

4101:1-19-01 This proposed rule sets for the provision for the design and construction of buildings and structural components using concrete.

4101:1-20-01 This proposed rule regulates the use of aluminum in building construction.

4101:1-21-01 This proposed rule prescribes requirements for masonry construction.

4101:1-22-01 This proposed rule regulates design and construction of structural steel, cold-formed steel, steel joists, steel cable structures, steel storage racks and composite construction.

4101:1-23-01 This proposed rule sets forth the requirements for design and construction of buildings that include wood or wood-based structural components.

4101:1-24-01 This proposed rule regulates the quality and design for glazing consisting of glass and light-transmitting plastics.

4101:1-25-01 This proposed rule prescribes requirements for design, construction and quality of gypsum board and plaster.

4101:1-26-01 This proposed rule sets forth the requirements for light transmitting and foam plastics.

4101:1-27-01 This proposed rule regulates electrical installations and references the National Electrical Code.

4101:1-28-01 This proposed rule regulates mechanical system installations and references the International Fuel Gas Code and Ohio Mechanical Code.

4101:1-29-01 This proposed rule regulates plumbing system installations and references Ohio Plumbing Code.

4101:1-30-01 This proposed rule regulates the installation of elevators and conveying systems not regulated by the Division of Industrial Compliance.

4101:1-31-01 This proposed rule prescribes requirements for construction and protection of structures having unique characteristics, such as temporary and membrane structures.

4101:1-32-01 This proposed rule regulates encroachments into the public right-of-way.

4101:1-33-01 This proposed rule sets for requirements for safeguards during construction.

4101:1-34-01 This proposed rule sets forth the requirements for alterations and additions of existing buildings and is based on 2012 International Building Code Chapter 34.

4101:1-35-01 This proposed rule lists technical standards referenced in rules 4101:1-1 through 4101:1-34.

4101:7-7-01 *This proposed new rule moves the Division of Industrial Compliance fee schedule from Ohio Administrative Code rule 4101:1-1-01 § 115 to this rule with no other changes to the fee schedule.*

Significant changes to these rules are listed in attached Exhibit A.

77 SOUTH HIGH STREET | 30TH FLOOR | COLUMBUS, OHIO 43215-6117

CSIOhio@governor.ohio.gov

2. Please list the Ohio statute authorizing the Agency to adopt this regulation.

Revised Code § 3781.10: <http://codes.ohio.gov/orc/3781.10>

Revised Code § 3781.11: <http://codes.ohio.gov/orc/3781.11>

Revised Code § 3791.04: <http://codes.ohio.gov/orc/3791.04v1>

3. Does the regulation implement a federal requirement? Is the proposed regulation being adopted or amended to enable the state to obtain or maintain approval to administer and enforce a federal law or to participate in a federal program?

If yes, please briefly explain the source and substance of the federal requirement.

Yes. Proposed rule 4101:1-11-01 sets forth the accessibility requirements for buildings and compliance with these provisions creates a “safe harbor” for compliance with federal accessibility requirements. The Department of Justice publishes regulations implementing the Americans with Disabilities Act (ADA) for title II (State and local government services) and title III (public accommodations and commercial facilities) and coordinates with the 2010 Standards for Accessible Design (“2010 Standards”) referenced by the proposed rules. The 2010 Standards can be found here: http://www.ada.gov/2010ADASTandards_index.htm

4. If the regulation includes provisions not specifically required by the federal government, please explain the rationale for exceeding the federal requirement.

Not applicable.

5. What is the public purpose for this regulation (i.e., why does the Agency feel that there needs to be any regulation in this area at all)?

Revised Code § 3781.10 directs the Board to “formulate and adopt rules governing the erection, construction, repair, alteration and maintenance of all buildings specified in section 3781.06 of the Revised Code...” Additionally, Revised Code 3781.06 provides:

Any building that may be used as a place of resort, assembly, education, entertainment, lodging, dwelling, trade, manufacture, repair, storage, traffic, or occupancy by the public, any residential building, and all other buildings or parts and appurtenances of those buildings erected within this state, shall be so constructed, erected, equipped, and maintained that they shall be safe and sanitary for their intended use and occupancy.

This statute defines safe and sanitary as follows:

“Safe,” with respect to a building, means it is free from danger or hazard to the life, safety, health, or welfare of persons occupying or frequenting it, or of the public and from danger

77 SOUTH HIGH STREET | 30TH FLOOR | COLUMBUS, OHIO 43215-6117

CSIOhio@governor.ohio.gov

of settlement, movement, disintegration, or collapse, whether such danger arises from the methods or materials of its construction or from equipment installed therein, for the purpose of lighting, heating, the transmission or utilization of electric current, or from its location or otherwise.

“Sanitary,” with respect to a building, means it is free from danger or hazard to the health of persons occupying or frequenting it or to that of the public, if such danger arises from the method or materials of its construction or from any equipment installed therein, for the purpose of lighting, heating, ventilating, or plumbing.

The Ohio Building Code (OBC) sets forth the construction standards for nonresidential buildings in the State of Ohio to ensure that they are safe and sanitary. Additionally, Revised Code § 3781.01 provides that local governments may not adopt regulations that conflict with the Board’s rules to facilitate the uniform application of the standards.

Revised Code 3781.11 lists conditions that rules of the Board must address, including:

- (1) For nonresidential buildings, provide uniform minimum standards and requirements, and for residential buildings, provide standards and requirements that are uniform throughout the state, for construction and construction materials, including construction of industrialized units, to make residential and nonresidential buildings safe and sanitary as defined in section 3781.06 of the Revised Code;
- (2) Formulate such standards and requirements, so far as may be practicable, in terms of performance objectives, so as to make adequate performance for the use intended the test of acceptability;
- (3) Permit, to the fullest extent feasible, the use of materials and technical methods, devices, and improvements, including the use of industrialized units which tend to reduce the cost of construction and erection without affecting minimum requirements for the health, safety, and security of the occupants or users of buildings or industrialized units and without preferential treatment of types or classes of materials or products or methods of construction;
- (4) Encourage, so far as may be practicable, the standardization of construction practices, methods, equipment, material, and techniques, including methods employed to produce industrialized units;

6. How will the Agency measure the success of this regulation in terms of outputs and/or outcomes?

The enforcement of these rules will be implemented by certified township, city, and county building departments. Rule 4101:1-1-01 lays out the administrative procedures certified building departments must follow to implement the substantive requirements of these rules to determine compliance. These provisions require a builder or owner to make application to a building department to obtain an approval to build (permit). As part of this application the owner must submit sufficient information and/or construction documents for the building official/plans examiner to determine whether the proposed work complies with the code. After the builder or owner obtains the approval (permit), construction may commence and the building department inspectors will inspect the construction to ensure that the work conforms with the original approval. Rule 4101:1-1-01 § 105.2 provides that in the absence of fraud or a serious safety or sanitation hazard, any non-residential structure built in accordance with approved plans shall be conclusively presumed to comply with these rules. The Board requires that certified nonresidential building departments submit an annual yearly operational report which lists the following information: current employees and their certifications, total number of permits issued during the year for each type of occupancy, total number of inspections made, the total value of construction, and the total number of appeals of the code requested by a builder or owner during the year.

Development of the Regulation

7. Please list the stakeholders included by the Agency in the development or initial review of the draft regulation.

If applicable, please include the date and medium by which the stakeholders were initially contacted.

The Board maintains a stakeholder distribution including building department personnel, contractors, designers and professional associations. The stakeholder list is available upon request. On October 7, 2016, the Board sent an email to all agency stakeholders informing them of a scheduled stakeholder meeting on October 28, 2016 to hear comments and respond to questions on these rules. The notice summarized the proposed amendments and also informed stakeholders that if they could not attend the stakeholder meeting, they could submit questions or comments via email or regular mail by November 2, 2016. On October 28, 2016, the Board conducted a stakeholder meeting on the proposed rules at 10:00 AM and the following individuals attended: Mike Thompson, DIC, Emily Kaylor, CSI, Brian Damant, Central Ohio Chapter, NECA, Paul Buehrer, City of Oregon, Michelle Grago, DIC, Citty, Buenconsejo, Creative Housing, John Labriola, Summit County, Aaron Lichtenauer, DODD, Jacalyn Slemmer, Disability Housing Network, Tim Thompson, SFM, Tracie Boyd, SFM, Doug

77 SOUTH HIGH STREET | 30TH FLOOR | COLUMBUS, OHIO 43215-6117

CSIOhio@governor.ohio.gov

Winder, US Green Building Council, Sarah Rice, Preview Group, Greg Bennett, Byers Minton – US GBC, and Chris Hess, Eaton.

8. What input was provided by the stakeholders, and how did that input affect the draft regulation being proposed by the Agency?

A copy of the correspondence the Board received in response to October 7, 2015 email and a summary of the October 28, 2016 stakeholder meeting are attached as Exhibit B. The initial comments received were reviewed by the Board’s Code Committee at its November 3, 2016 and December 8, 2016 meetings. Additionally, the Board received Petition 16-16 submitted by the Ohio Electrical Coalition requesting updating the National Electrical Code (NEC) NFPA 70 from the 2014 edition to the 2017 edition, Petition 16-10 submitted by the Ohio Building Officials Association (OBOA) to amend the certification requirements for plans examiners, and Petition 16-09 submitted by Pete Baldauf requesting changes to Section § 1008.1.10. Petitions 16-09, 16-10 and 16-16 are attached as Exhibit C.

Numerous letters for support were submitted for adoption of the 2017 NEC. Additionally, both Brian Damant, NECA, and Brian Hess, Eaton who attended the October 27, 2016 stakeholder meeting indicated support for the adoption of the 2017 NEC. At its November 3, 2016 meeting, the Board’s code committee recommended approval of Petition 16-10.

After working with the OBOA to develop alternative language the language proposed by Petition 16-10, approved modifications were included in proposed rule 4101:1-1-01 and an accompanying rule package amending the Board’s certification rules that would allow more avenues to qualify for plans examiner certifications.

While the Board’s code committee recommended denial of Mr. Baldauf’s Petition 16-09, the committee worked with Mr. Baldauf to developed alternative language include in the rule package to address Mr. Balfauf’s concerns for coordination between proposed rules and the National Electrical Code.

The remaining substantive comments were submitted by Critty Buenconsejo, Creative Housing, who attended the October 27, 2016 stakeholder meeting and submitted written comments requesting clarification to the proposed changes to rule 4101:1-3-01 for institutional occupancies as they would apply to group homes and written comments submitted by Pete Baldauf regarding plan review of fire protection systems by electrical plans examiners. The Board’s code committee agreed with Mr. Baldaulf’s comment and removed the limitation for the plans examination of fire protection systems. The Board’s code committee also responded to Ms. Buenconsejo revised rule 4101:1-3-01 attempting to provide further clarifications for institutional occupancies.

77 SOUTH HIGH STREET | 30TH FLOOR | COLUMBUS, OHIO 43215-6117

CSIOhio@governor.ohio.gov

9. What scientific data was used to develop the rule or the measurable outcomes of the rule? How does this data support the regulation being proposed?

The proposed rules are based on the 2015 International Building Code (IBC) promulgated and amended by the International Code Council (ICC). The model codes developed by ICC are updated every three years through a process that incorporates petitioning, public hearings and voting by ICC members. The ICC Committees that oversaw the development of the different provisions 2015 IBC included building and fire code officials, architects, engineers, contractors, and representatives from the National Association of Home Builders, Underwriters Laboratories, and other professional organizations.

When a petition to amend the model code is submitted, the proponent of the change must submit the proposed language of the amendment, the reason for the amendment including scientific data when applicable, and the cost impact of the amendment. All submitted petitions are then published prior to initial code development hearings on the petitions. Interested persons may review the proposed changes and attend the code development hearing and provide comments. A report then is published on the public hearings for review and then final action is taken on the proposed changes at final action hearings. All successful changes are incorporated into the next edition of the model code.

Upon publication the Board's code committee reviews each substantive change included in the newest edition of the code and determines whether to recommend the change to the Board for adoption. The Board last fully updated the OBC on November 1, 2011.

10. What alternative regulations (or specific provisions within the regulation) did the Agency consider, and why did it determine that these alternatives were not appropriate? If none, why didn't the Agency consider regulatory alternatives?

See Question 9.

11. Did the Agency specifically consider a performance-based regulation? Please explain.

Performance-based regulations define the required outcome, but don't dictate the process the regulated stakeholders must use to achieve compliance.

The rules permit a registered design professional's alternative engineered design to be a compliance alternative method to the prescriptive requirements of the code. Section 106.5 of the OBC permits a registered design professional to submit sufficient technical data to substantiate that performance of the proposed alternative engineered design meets the intent of the code. Additionally, section 107.4.3 provides that when construction documents have been prepared by an Ohio registered design professional conforming to the requirements of the rules of the Board pertaining to design loads, stresses, strength, and stability and other requirements involving technical analysis, the documents need only be

77 SOUTH HIGH STREET | 30TH FLOOR | COLUMBUS, OHIO 43215-6117

CSIOhio@governor.ohio.gov

examined to the extent necessary to determine conformity with other requirements of the rules of the Board.

12. What measures did the Agency take to ensure that this regulation does not duplicate an existing Ohio regulation?

Editorial changes are routinely made to the rules to provide consistency with the Ohio Revised Code and other Board and agencies' rules. Additionally, RC § 3781.10 gives the Board sole authority to adopt rules which regulate the erection, construction, repair, alteration, and maintenance of all buildings or classes of buildings specified RC 3781.06 including residential and non-residential buildings.

13. Please describe the Agency's plan for implementation of the regulation, including any measures to ensure that the regulation is applied consistently and predictably for the regulated community.

For these rules to be enforced by a local government, its building department must be certified by the Board. The Board also certifies the personnel who work within these departments to ensure only qualified personnel are enforcing the Board's rules. Certified personnel must complete continuing education to maintain their certifications and continue to be authorized to enforce these rules. The Board has authority to suspend or revoke certifications for failure to properly enforce the rules. Also, the Board has a staff member dedicated to responding to complaints by persons affected by the Board rules. This program helps promote consistent and predictable application of the Board rules.

Adverse Impact to Business

14. Provide a summary of the estimated cost of compliance with the rule. Specifically, please do the following:

a. Identify the scope of the impacted business community;

- Building owners
- Design Professionals
- Contractors
- Building Department Personnel

b. Identify the nature of the adverse impact (e.g., license fees, fines, employer time for compliance); and

- Obtaining updated rules as published as the Ohio Building Code
- Becoming familiar with the changes through research and training

77 SOUTH HIGH STREET | 30TH FLOOR | COLUMBUS, OHIO 43215-6117

CSIOhio@governor.ohio.gov

- Increased cost of construction due to changes that require different construction methods/materials/products or increased stringency of construction standards.

c. Quantify the expected adverse impact from the regulation.

The adverse impact can be quantified in terms of dollars, hours to comply, or other factors; and may be estimated for the entire regulated population or for a “representative business.” Please include the source for your information/estimated impact.

Due to the variance in allowed building designs, it is difficult to ascertain, in dollars, a cost increase/decrease in the design cost of a building as a result of the proposed code update. However, as discussed in Question 9 above, when a code change proponent submits a petition to ICC to amend the model code an estimated cost impact of the proposal is included. Of the significant changes, the following sections included in the proposed rules were noted by the proponent as having a cost increase in construction:

Section 90.7 - Carbon monoxide alarms – Group I & R with fuel fired appliances

Section 909.21.1 – Elevator hoistway pressurization measurements

Section 915 - Carbon monoxide detection in Group I, R & E classrooms

Section 1029.1.1.1 – Separation of spaces under grandstands and bleachers

Section 1203.1 – Mechanical ventilation required in dwelling units <5ACH50

Sections 1404.12 & 1405.18 – Polypropylene siding materials fire spread & fire separation distance

Section 1507.16 – Fire resistance of roof supporting roof gardens and landscaped roofs

Section 1705.16 – Special inspection of fire-resistant penetration & joint systems mandatory for high-rise buildings and Risk Category III or IV

Section 3008 – Occupant evacuation elevator requirements coordinated with provisions for fire service access elevators

Additionally, as a result of approved Petition 16-16 updating the NEC reference to the 2017 edition will have impact on cost of construction to comply with new electrical requirements.

The new Ohio Building Code publication will be available from publishers at an approximate cost of \$150.

15. Why did the Agency determine that the regulatory intent justifies the adverse impact to the regulated business community?

77 SOUTH HIGH STREET | 30TH FLOOR | COLUMBUS, OHIO 43215-6117

CSIOhio@governor.ohio.gov

The majority of the provisions noted above as having an increased cost impact enhance life safety provisions of the code. Additionally, other changes included in the rule package will decrease cost of construction, offer regulatory alternatives, and recognize new technologies and materials. For instance, as described in Petition 16-06 in Exhibit C, the 2017 NEC may provide relief on the overall cost of the electrical system:

- New exception for bank and office occupancies permitting reduction of lighting load based on allowable load density prescribed by adopted energy codes. This may grant substantial relief for sizing of service and feeder distribution systems.
- Deletion of Table 310.15(B)(3)(c). This removes the required temperature adder for ambient temperature adjustment correction when calculating conductor size for conductors installed on rooftops exposed to sunlight unless conductors are installed 7/8" or closer to the roof.
- Expansion of use of 83% reduction for 3-conductor (2 hots and a neutral) feeders derived from either single or three phase supplies.
- Revised to only require cables with 10 AWG and smaller conductors to default to the 60 degree C ampacity where installed in insulation.
- New language covering any of the GFCI requirements involving a measurement to determine receptacle proximity.
- Revision to permit any appliance installed in rooms or areas required to be supplied by a 20 ampere small appliance branch circuit to be supplied from an individual branch circuit rated 15 amperes or greater.
- Revisions to only require a receptacle for service equipment located indoors and new exception for services rated more than 120 volts to ground that supply certain types of equipment.

Finally, until the current edition the Board updated the codes every three years. The Board has taken steps to lengthen the time between code updates to reduce the impact on the construction community. To date, however, 14 states have already adopted the 2015 IBC and another 19 have adopted the 2012 IBC. Projects are designed months and years in advance. Design professionals need predictability to be able to design the appropriate standards. This update will keep Ohio's code aligned with the majority of other states.

Regulatory Flexibility

16. Does the regulation provide any exemptions or alternative means of compliance for small businesses? Please explain.

The rules do not have special exemptions or alternative means of compliance specifically for small business. The OBC requires a building official to issue an adjudication order to an owner when the design or construction of a building does not comply with the OBC. The adjudication order must comply with Revised Code Chapter 119 and give the owner an opportunity to appeal. This mechanism is often utilized by an owner voluntarily to obtain a

77 SOUTH HIGH STREET | 30TH FLOOR | COLUMBUS, OHIO 43215-6117

CSIOhio@governor.ohio.gov

variance from the requirements. Variance requests are heard by either the Ohio Board of Building Appeals or a certified local board of building appeals.

Also, the OBC permits alternative engineered designs prepared by a registered design professional to not strictly comply with the prescriptive requirements of the rules. To obtain approvals based on alternative engineered designs, the design professional must submit sufficient technical information to demonstrate that the performance meets the intent of the rules.

17. How will the agency apply Ohio Revised Code section 119.14 (waiver of fines and penalties for paperwork violations and first-time offenders) into implementation of the regulation?

Revised Code § 3781.102 does not authorize the Board to set the fees and/or penalties assessed by local certified building departments in connection with the enforcement of these rules. Compliance with the rules is accomplished through construction conforming to the certificate of plan approval (permit). Therefore, there are no potential paperwork violations of these rules.

18. What resources are available to assist small businesses with compliance of the regulation?

As these proposed rules updates the Ohio Building Code to a new model code edition, the Board offers training and resources to building department personnel to prepare them to enforce the new codes. These resources are paid for by assessment fees collected by certified building departments pursuant to RC 3781.102 on behalf of the Board to be used exclusively for (1) the operating costs of the Board, (2) providing services, including educational programs, for building departments certified by the Board, and (3) paying the expenses of the Residential Construction Advisory Committee.

Additionally, the Board's technical staff spends approximately 25% of their time responding to questions on the building codes and educating design professionals, contractors, the public, and code officials of the intent of the Board's rules assisting all parties in compliance.

Ohio Building Code Summary of Significant Changes - 2012 and 2015

OBC Rule	OBC Section	Source of Change	Description	
4101:1-1-02	Congregate Living Facilities	2012	Moving definitions to Chapter 2	
	Custodial Care	2012	New definition	
	Horizontal Exit	2015	Definition clarification as an exit component	
	Platform	2015	Permitting horizontal sliding curtains	
	Private Garage	2015	Limiting to tenant vehicles	
	Treated wood	2015	Allowing other than pressure treatment	
4101:1-1-03	303.1.3	2012	Assembly rooms associated with Group E occ.	
	303.3	2012	Occupancy classification for casino gaming floors	
	304.1	2012/2015	Food processing/training and skill development facilities	
	306.2	2015	Food processing facilities and commercial kitchens	
	T307.1(1)	2012	Facilities generating combustible dust	
	308.2	2012	Care facility definitions	
	308.3	2015	Group I-1 occupancy classification – conditions 1 & 2	
	308.4	2012/2015	Group I-2 occupancy classification – 5 or less/ conditions 1 & 2	
	310	BBS	Ohio changes to Chapter 3 for simplification	
	310.3.3	BBS	Vacation Rental (Cabin, Cottage, Bungalow, Chalet) (Transient).	
	310.5	2015	Group R-3 lodging houses ≤ 5	
	310.6	2012/2015	Group R-4 occupancies > 5 but ≤ 16/ conditions 1 & 2	
	311.1.1	2015	Classification of accessory storage spaces as S occupancy	
	4101:1-4-01	402	2012	Open mall buildings added
		403.1 Exceptions 1 & 3	2015	Application of high-rise provisions to A-5 and H occupancies
		403.6.1	2012	High-rise building fire service access elevator number increase
404.5 Exception		2015	Atrium smoke control in Group I-1 & I-2 occupancy exceptions	
404.9, 404.10		2015	Egress travel through an atrium	
406.3.1		2015	Private garage floor area limitations	
406.3.2		2015	Private garage ceiling height	
406.4		2012	Public parking garages – clear height, guards, vehicle barriers	
406.5.2.1		2012	Open parking garages openings below grade	
406.5.5		2012	Open parking garages height and area increases	
407.2.5		2015	Group I-2 nursing home shared living spaces	
407.2.6		2015	Group I-2 nursing home cooking facilities	
407.5		2015	Maximum size of Group I-2 smoke compartments	
410.3.5		2015	Horizontal sliding doors at stage proscenium openings	
410.6.3		2012	Technical production areas	
412.4.6.2		2012	Aircraft hangar fire areas	
412.7		2015	Travel distance in aircraft manufacturing facilities	
414.5		2012	Inside storage, dispensing, and use of hazardous materials	
419		2012	Live/work units – egress & nonresidential plumbing facilities	
422	2012	Ambulatory care facilities		
423.3	2015	Storm shelters serving critical emergency operations facilities		
423.4	2015	Storm shelters serving Group E occupancies		

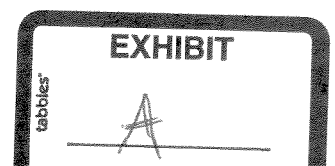

Ohio Building Code Summary of Significant Changes - 2012 and 2015

	424	2012	New language for children's play structure requirements inside
	426	2015	Combustible dusts, grain processing, and storage
4101:1-5-01	501.2	2012/2015	Address identification additional locations
	503	2015	General height & area limitations in separate tables
	T504.3, 504.4	2015	Building height and number of stories – 2 tables
	505.2.2	2012	Mezzanine means of egress must comply with Ch. 10
	505.2.3 Exception 2	2015	Mezzanine openness with access to 2 or more exits
	506.2	2012	Allowable area frontage increase width limits
	T506.2	2015	Building area in a separate table
	507.1	2012/2015	Unlimited area buildings accessory occupancies/basements
	507.8	2012	Unlimited area buildings Group H occupancies
	507.9	2015	Unlimited area buildings with Group H-5
	509	2012	Incidental uses general provisions; separation and protection
	T509	2012/2015	Incidental uses rooms or areas/fire protection from
	510.2	2015	Horizontal building separation
4101:1-6-01	T601 Footnote D	2015	One-hour substitution for suppression removed from table
	T602 Note H	2012	Fire ratings of exterior walls permitted to have unlimited, unprotected openings
	602.4	2015	Type IV member size equivalencies for wood members
	602.4.2	2015	Cross-laminated timber in exterior walls
	603.1 Item 26	2015	Wall construction of freezers and coolers
4101:1-7-01	701.2	2012	Multiple-use fire assemblies
	703.4	2012	Establishing fire resistance ratings established w/o suppression
	703.7	2012	Identification of fire & smoke separation walls w/signage - DELETED
	704.4	2015	Protection of secondary members
	704.11	2012	Fire protection of bottom flanges – to 6' 4"
	705.2	2012/2015	Extent of projections beyond exterior walls/projections at exterior walls
	705.2.3	2012/2015	Protection of combustible projections/combustible projections
	705.3	2012/2015	Projections from buildings on the same lot/buildings on the same lot
	705.6	2015	Structural element bracing of exterior walls
	705.8.5	2015	Vertical separation of openings in walls rated from both sides
	706.2	2012/2015	Double fire walls/structural stability of fire walls to NFPA 221
	706.6, 706.6.2	2012	Fire wall height at sloped roofs
	707.8, 707.9	2012	Voids crated at intersections of fire barriers at roof assemblies
	709.4	2012/2015	Continuity of smoke barriers/continuity of smoke barriers
	711	2015	Floor and roof (horizontal) assemblies and vertical openings
	712	2012/2015	New language for reorganizing and clarifying vertical openings from section on shaft enclosures
	713.13	2012	Refuse and laundry chutes in Group I-2 occupancies
	713.13.4	2012	Fire protection of refuse, recycling, laundry termination rooms
	713.14.1	2012	High-rise buildings elevator lobbies at level of exit discharge

Ohio Building Code Summary of Significant Changes - 2012 and 2015

	714.4.1.1.2	2012	Floor penetrations of horizontal assemblies for drains
	714.4.1.2	2012	Interruption of horizontal assemblies exceptions
	714.4.2	2015	Membrane penetrations in horizontal membranes
	714.5, 715.6	2012	L ratings for penetrations in smoke barriers
	715.4	2012	Exterior curtain wall/floor intersection and F rating
	716.3	2012	Marking of fire-rated glazing assemblies & new table
	T716.5	2012	Opening protection ratings and markings
	716.5.5.1	2012	Glazing in exit enclosure and exit passageway doors
	T716.6	2012	Fire-protection-rated glazing
	716.6.4	2012	Wired glass in fire window assemblies essentially removed
	717.1.1	2015	Ducts transitioning between shafts
	717.3, 717.5	2015	Corridor dampers
	717.5.4	2012	Fire damper exemption for fire partitions
	718.2.6	2012	Fireblocking within exterior wall coverings (architectural trim)
4101:1-8-01	803.12	2012	Polypropylene (PP) added to high-density polyethylene (HDPE)
	804.4	2012	Interior floor finish requirements in unseparated spaces
4101:1-9-01	901.8	2012	Pump and riser room size for clearances
	903.2.1.6	2015	Sprinkler systems - when assembly occupancies are on roofs
	903.2.1.7	2015	Suppression for multiple Group A fire areas w/ shared exits
	903.2.2	2012	Sprinklers in buildings w/ambulatory care facilities on other than level of exit discharge
	903.2.4, 903.2.7, 903.2.9	2012	Furniture storage and display in Group F-1, M, and S-1 occupancies – Ohio modifications
	903.2.8	2015	Sprinkler systems-Group R-4 – conditions 1, 2, attics
	903.2.11.1.3	2012	Sprinkler protection for basements
	903.2.11.2	2012	Sprinkler protection of rubbish and linen chutes
	903.3.1.1.2	2015	Exempt locations for NFPA 13 sprinklers
	903.3.1.2.2	2015	Suppression for open-ended corridors
	903.3.5.2	2012	Secondary water supply operation
	903.3.8	2015	Limited area sprinkler systems restrictions
	904.3.2	2012	Design for actuation of multiple fire-extinguishing systems
	904.13	2015	Domestic cooking systems in Group I-2 Condition 1
	905.4	2012	Location of Class 1 standpipe hose connections
	906.1	2012	Portable fire extinguishers in Group R-2 occupancies
	907.2.1	2012	Fire alarms systems in Group A occupancies
	907.2.1.2	2012	Emergency voice/alarm communication captions in Group A-5
	907.2.3	2012/2015	Group E fire alarm systems/fire alarms-Group E occupancies
	907.2.9.3	2012/2015	Smoke detection in Group R-2 college buildings/alarm systems-Group R-2 college and university buildings
	907.2.11.3	2012/2015	Wireless interconnection of smoke alarms
	907.2.11.3, 907.2.11.4	2015	Smoke alarms near cooking appliances and bathrooms
	908.7	2012	Carbon monoxide alarms-Group I & R with fuel fired appliance
	909.21.1	2015	Elevator hoistway pressurization measurements
	910	2015	Smoke and heat removal & alternative to smoke & heat vents rewrite

Ohio Building Code Summary of Significant Changes - 2012 and 2015

	915	2015	Carbon monoxide detection in Group I, R, & E classrooms
4101:1-10-01	1001.4	2012	Fire safety and evacuation plans
	1004.1.1	2015	Cumulative occupant loads
	1004.1.2	2012	Design occupant load-areas without fixed seating
	T1004.1.2	2012/2015	Occupant load factors – Group M
	1005	2012	Reorganized means of egress capacity determination/sizing
	1006, 1007	2012/2015	Accessible means of egress/numbers of exits and exit access doorways
	1006.3	2015	New language for egress from stories or occupied roofs
	1007.1	2015	Exit and exit access doorway configuration – separation
	1008.1.9.9	2012	Electromagnetically locked egress doors
	1009, 1010	2012	Interior stairways and ramps requirement language revisions
	1009.1	2012	Application of stairway provisions to all stairs
	1009.8	2015	Two-way communication systems in specific elevators
	1010.1.9	2015	Door operations-locking systems language coordination
	1011.2	2012	Floor-level exit signs in Group R-1
	1011.15, 1011.16	2015	Locations where ladders can be used for access
	1012.1, 1013.8	2012	Exit and exit access doorway configuration
	1012.2	2012	Handrail height exceptions
	1012.3.1, 1012.8	2012	Handrail graspability and projections - graspability
	1013.1, 1013.8	2012	Guards at operable windows ≤ 36" AFF
	1013.3	2012	Guard height measurement & exceptions
	1014.8	2015	Intermediate handrail projections
	1016.2	2015	Egress through intervening spaces/elevator lobbies
	1017.2.2	2015	Travel distance increase for Groups F-1 and S-1
	1018.3	2015	Aisles in Groups B and M
	1020.2	2015	Corridor width and capacity & Group I-2 exception
	1021.2	2012	Exits from stories – new exception
	1021.2.1	2012	Calculation of single exits from mixed occupancy buildings
	1021.2.3, T1021.2(1)	2012	Single exits from dwelling units - clarification
	1022.5	2012	Enclosure penetrations of the outside of interior exit stairs
	1023.3.1	2015	Stairway extension with exit passageway with no openings
	1028.1.1.1	2012	Separation of spaces under grandstands and bleachers
	1029.13.2.2.1	2015	Stepped aisle construction tolerances for maintaining view lines
4101:1-11-01	1103.2.8	2015	Raised or lowered areas in places of religious worship – ALREADY DONE IN OHIO
	1104.3.1	2012	Employee work areas < 1000ft ² – ALREADY DONE IN OHIO
	1104.4	2015	Multistory buildings and facilities & mezzanines – ALREADY DONE IN OHIO
	1107.3, 1107.4	2015	Accessible spaces and routes – exceptions – ALREADY DONE IN OHIO
	1107.5.1.1, 1107.6.4.1	2015	Accessible units in assisted living facilities – Group I & R
	1107.6.1	2012	Reduction in accessible units in Group R-1 occupancies
	1107.6.1.1	2015	Method for determining number of Group R accessible units – ALREADY DONE IN OHIO
	1108.2.7.3	2012	Captioning of public address announcements, ≥15,000 seats – ALREADY DONE IN OHIO

Ohio Building Code Summary of Significant Changes - 2012 and 2015

	1109.2, 1109.5	2012/2015	Accessible children's facilities- ALREADY DONE IN OHIO /accessible water closet compartments
	1109.2.3	2015	Accessible lavatories in & out of an accessible compartment - ALREADY DONE IN OHIO
	1109.6	2012	Accessible saunas and steam rooms- ALREADY DONE IN OHIO
	1110	2015	Recreational facilities serving various occupancies - ALREADY DONE IN OHIO
	1110.4	2012	Variable message signs in transportation & emergency shelters- ALREADY DONE IN OHIO
4101:1-12-01	1203.1	2012	Mechanical ventilation required in dwellings units <5ACH50
	1203.2	2012	Ventilation of attic spaces - exceptions
	1203.3	2015	New provisions for unvented attics and unvented enclosed rafter assemblies.
	1208.3	2012	Minimum kitchen floor area in dwelling units removed
	1210	2012	Toilet and urinal partition requirements inserted from Ch. 29
4101:1-13-01	-	-	-
4101:1-14-01	1403.5	2012	Flame propagation testing for exterior walls
	1404.12, 1405.18	2012	Polypropylene siding materials fire spread & fire separation distance
	1405.3	2015	Vapor retarder types required in certain zones
	1405.6	2012	Anchored masonry veneer joint reinforcement deleted for buildings in Seismic Design Category D
4101:1-15-01	1503.4	2012	Sizing requirements for secondary roof drainage system
	1507.2.8.1	2012	Requirements for roof covering underlayment in high wind areas >120 mph
	1507.16	2012	Fire resistance of roof supporting roof gardens and landscaped roofs
	1507.17	2012	Photovoltaic module/shingle system requirements
	1509	2012	Rooftop structures language reorganization/clarification
	1510.3	2012	Roof covering replacement and existing ice guard
4101:1-16-01	1602.1	2015	Definitions and notations - remove flexible & rigid diaphragm
	1602.2	BBS	Move posting requirement previously in Ch.16 but in IBC Ch. 1
	1603	2015	Two new construction document requirements-snow load data
	1603.1.7	2015	Flood design data terminology change
	1603.1.8	2015	Special loads - dead load for photovoltaic systems
	1604.3	2015	Deflection limit changes for serviceability
	T1604.3	2012	Deflection limits table footnotes added
	1604.5	2012/2015	Risk categories/risk category table in IBC to be used not ASCE 7
	1605.2	2012	Load combinations using strength design of load and resistance factor design equations coordinated w/ASCE 7
	1605.3	2012	Load combinations using allowable stress design equations coordinated w/ASCE 7
	T1607.1	2012	Minimum live loads - coordinate with ASCE 7

Ohio Building Code Summary of Significant Changes - 2012 and 2015

	1607.5	2015	Partition loads
	1607.6	2012	Helipads terminology and loads coordinated with ASCE 7
	1607.7	2012	Heavy vehicle load modifications
	1607.9	2015	Impact loads for facade access equipment
	1607.10.2	2015	Alternative uniform live load reduction
	1607.12	2015	New provisions for roof loads for vegetative & landscaped roofs
	1607.12.5	2015	New requirements for design of photovoltaic panel system
	1608.3, 1611.2	2012	Roof design for ponding instability
	1609	2012	Determination of wind loads as ultimate design wind speed & maps per Risk Category
	1609.1.1	2015	Determination of wind loads testing to ASCE 49
	1613.3.1	2012/2015	Updated mapped acceleration parameters NEHRP/mapped acceleration parameters for Guam and American Samoa
	1613.4	2012	IBC alternatives to ASCE 7
	1613.5	2015	Amendments to ASCE 7 language for anchorage forces in diaphragms
	1613.6	2015	Seismic provisions for ballasted photovoltaic panel systems
	1614	2012	Atmospheric ice loads for ice-sensitive structures
4101:1-17-01	1704.3	2012	Requirements for statement of special inspections clarified
	1704.5, 1704.6	2015	Submittals to the building official/observation- DELETED
	1705.2	2012/2015	Special inspection of steel construction/steel construction now in ANSI/AISC 360
	1705.2.3	2015	New table for open web steel joists and joist girders
	T1705.3	2012/2015	Required verification and inspection of concrete construction/required special inspections of concrete construction
	1705.4	2012	Special inspection of masonry construction now in TMS 402/ACI 530/ASCE 5 and TMS 602/ACI 530.1/ASCE 6
	1705.11	2015	Special inspection for wind resistance clarified
	1705.12	2015	Special inspection for seismic resistance clarified
	1705.16	2012	Special inspection of fire-resistant penetration & joint systems mandatory for high-rise buildings and Risk Category III or IV
	1708.3.2	2015	Static load testing requirements clarified
	1709.5	2015	Design pressure ratings for exterior window and door assemblies done on an allowable stress design basis
	1711	2015	Material and test standards for joist hangers removed and testing for concrete and tile roofs moved to Ch. 15
4101:1-18-01	1803.5	2015	Investigation of rock conditions for foundations updated
	1803.5.1.2	2012	Geotechnical reports for foundation walls and retaining walls in SDC D, E, F w/ >6' backfill
	1804.1	2015	Excavation near foundations – underpinning requirements
	1808.3	2015	Design surcharge loads on adjacent structures added
	1810.2.5	2015	Evaluation of group effects – deep foundation elements
	1810.3	2015	Design and detailing for structural sheet piles added
	1810.3.3.1.6	2012	Uplift capacity of grouped deep foundation elements
4101:1-19-01	1901.3	2015	Anchorage to concrete now refers to ACI 318
	1901.4	2015	Composite structural steel and concrete structures relocated

Ohio Building Code Summary of Significant Changes - 2012 and 2015

	1904	2015	Durability requirements refer to ACI 318
	1905.1.3	2012/2015	Seismic detailing of wall piers/modifications to ACI 318, section 18.5
	1905.1.8	2012/2015	Plain concrete footings in dwelling construction/modifications to ACI 318, section 17.2.3
	1905.1.9	2012	ACI 318 modifications for shear wall to concrete foundation connections
4101:1-20-01	-	-	-
4101:1-21-01	2101.2	2012/2015	Design methods for masonry structures/masonry design methods to TMS 602/ACI 530.1/ASCE 6
	2103	2015	Masonry construction materials to TMS 602/ACI 530.1/ASCE 6
	2104	2015	Masonry construction provisions to TMS 602/ACI 530.1/ASCE 6
	2105	2015	Quality assurance of masonry to TMS 602/ACI 530.1/ASCE 6
	2111, 2113	2015	Masonry fireplaces and chimney design reorganized & clarified
4101:1-22-01	2206	2012	Composite structural steel and concrete structures to AISC 341
	2210	2015	Steel Deck Institute standard SDI-C for composite slabs on steel decks added
	2210.2	2012	Standards added for seismic requirements for cold-formed steel structures
	2211	2015	AISI S220 added for cold-formed steel light-framed construction
4101:1-23-01	2303.1.4	2015	New definition and standard added for structural glued cross-laminated timber
	2303.1.13	2015	New definition and standard added for engineered wood rim board
	2304.6	2015	Structural performance for exterior wall sheathing added
	T2308.7.1, T2308.7.2	2015	Incorporated updated stress values/spans per AWC STJR (including for southern pine)
	2304.10.6	2015	Steel straps thickness for discontinuous wood members per AISI S201
	2304.12	2015	Locations for waterborne preservatives are required to protect against decay and termites
	2305	2012	General design requirements for lateral-force-resisting systems coordinated with AF&PA SDPWS-08
	2306	2012	Allowable stress design coordinated with AF&PA SDPWS-08
	2307	2012	Load and resistance factor design coordinated with AF&PA SDPWS-08
	2308	2015	Conventional light-framed construction language reorganized and clarified
	2308.2.5	2015	Allowable roof span limitations clarified
	2308.7	2015	Roof and ceiling framing span tables from IRC incorporated into IBC
	2308.12	2012	Braced wall line sheathing using percentage rather than lengths

Ohio Building Code Summary of Significant Changes - 2012 and 2015

	2309	2015	Wood frame construction manual referenced in new section for buildings in Risk Category I or II
4101:1-24-01	2406.1, 2406.4	2012	Safety glazing-hazardous locations reorganized and clarified to better coordinate between IRC and IBC
	2406.2	2012	Default safety glazing-impact test criteria revised
	2406.4.7	2015	Safety glazing clearances adjacent to bottom stair landing revised and clarified
4101:2-25-01	2510.6	2012	Detailed requirements for water-resistive barriers for stucco applications added
4101:2-26-01	2603.4.1.14	2012	Wood structural panels permitted for thermal barrier for foam plastic insulation installed in floor assemblies
	2603.7, 2603.8	2012	Three options for separating foam plastic insulation used in interior plenum spaces
	2603.10, 2603.10.1	2012	Special approval required of assemblies containing of foam plastic for smoke development
	2610.3	2012	Method for determining the minimum slope requirements of a dome skylights added
	2612	2012/2015	Limits set for the use of fiber-reinforced polymer/plastic composites on an exterior wall
4101:1-27-01	-	-	-
4101:1-28-01	-	-	-
4101:1-29-01	2902.2	2012	Single-user toilet facilities as alternate to separate toilet by gender when, if done, required only one to be accessible
	2902.3	2012/2015	Toilet facilities in parking garages/public toilet facilities exceptions added
	2902.3.5	2012	Restrictions for locking of multi-fixture toilet room doors
	2902.5	2012	Multi-tenant drinking fountain locations and distances
4101:1-30-01	3004	2015	Deletion of elevator hoistway venting coordinating with ASMEA17.1
	3006	2015	Relocated elevator lobby requirement to elevator chapter
	3007	2012	Fire service access elevator requirements coordinated with provisions for occupant evacuation elevators
	3008	2012	Occupant evacuation elevator requirements coordinated with provisions for fire service access elevators
4101:1-31-01	3108	2012	Telecommunication and broadcast tower standard seismic provisions coordinated with ASCE 7
4101:1-32-01	-	-	-
4101:1-33-01	3302.3, 3303.7, 3313	2012	Requirements for fire safety during construction included from IFC to assure they are not overlooked
4101:1-34-01	Chapter 34	BBS	The Board has kept Chapter 34 and updated the 2012 version to include in the 2015 OBC update
	3401.1.1	BBS	Existing building compliance options spelled out.
	3401.3	2012	Compliance for existing buildings
	3411	2012	Type B units in existing buildings

**October 28, 2016 Stakeholder Meeting
Ohio Building Code Update Rules**

Attendees:

Mike Thompson, DIC
Emily Kaylor, CSI
Brian Damant, Central Ohio Chapter, NECA
Paul Buehrer, City of Oregon
Michelle Grago, DIC
Crittty Buenconsejo, Creative Housing
John Labriola, Summit County
Aaron Lichtenauer, DODD
Jacalyn Slemmer, Disability Housing Network
Tim Thompson, SFM
Tracie Boyd, SFM
Doug Winder, US Green Building Council
Sarah Rice, Preview Group
Greg Bennett, Byers Minton – US GBC
Chris Hess, Eaton

Staff Present:

Regina Hanshaw
Steve Regoli
Debbie Ohler
Jay Richards
Rob Johnson

Board Members Present:

Dave Collins

Board presented overview of proposed changes to the Ohio Building Code (attached).

Comments Submitted:

Ms. Buenconsejo, Creative Housing, asked about the impact the proposed changes to Chapter 3 and definitions would impact facilities that rent to individuals with disabilities requiring care. After general discussion, Board Staff indicated that the language would be reviewed to determine how the proposed language may impact residential facilities housing five or fewer individuals requiring some level of care.

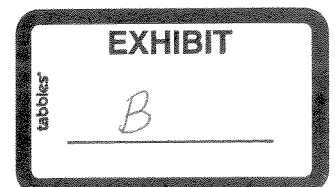

Brian Damant, NECA, indicated support for adoption of the 2017 NEC and asked for sufficient lead time to prepare training on the new electrical code.

Brian Hess, Eaton, also indicated support for adoption of the 2017 NEC.



Southwest Division

Ohio Chapter, Western Section, I.A.E.I.

International Association of Electrical Inspectors

<http://www.swohioiaei.org/>

Board of Directors

Gaylord Poe, President
Inspection Bureau, Inc.
250 W. Court St.
Cincinnati, Ohio 45202
Phone: (513) 977-4394
Fax: (513) 381-6123
E-Mail: gpoe@inspectionbureau.com

Dewayne Jenkins, 1st V.P.
City of Kettering
1600 Shroyer Rd.
Kettering, Ohio 45429
Phone: (937) 296-2419
Fax: (937) 296-3240
E-Mail: Dewayne.jenkins@ketteringohio.org

Pete Baldauf, Legislation
City of Vandalia
3887 Reimswood Dr.
Dayton, Ohio 45414
Phone: (937) 415-2326
Fax: (937) 415-2319
E-Mail: PBaldauf@cityofvandalia.org

Lorenzo Adam, Secretary
City of Mason
6000 Mason-Montgomery Rd.
Mason, Ohio 45040
Phone: (513) 229-8520
Fax: (513) 229-8521
E-Mail: ladam@masonohio.org

Ken Dunning – Treasurer
10177 Zig Zag Rd.
Cincinnati, Ohio 45242
Phone: (513) 984-3963
Fax: (513) 984-1232
E-Mail: csoski@cojohanna.com

Active Inspector Members

Caty Robinson
Inspection Bureau, Inc.
250 W. Court St.
Cincinnati, Ohio 45202
Phone: (513) 977-4394
Fax: (513) 381-6123
E-Mail: Crobinson@inspectionbureau.com

John Keller
Ohio Department of
Rehabilitation & Correction
Phone: (937) 372-0797
E-Mail: jkeller@ohd.com

Associate Member

Ken Carr
Carr Electric Co.
Phone: (513) 574-3753
E-Mail: ken@carr-electric.com

10/11/16

Regina Hanshaw
Ohio Board of Building Standards
6606 Tussing Rd.
P.O. Box 4009
Reynoldsburg, OH 43068-9009

RE: 2017 NEC

Dear Ms. Hanshaw,

The SW Division IAEI, representing 19 southwest Ohio counties, fully supports the proposals initiating Ohio's adoption of the 2017 NEC outlined in the proposed sections for update in all three codes:

4101:1-35-01 Referenced standards: ~~70-14 National Electrical Code~~ 70-17 National Electrical Code (Ohio Building Code)

4101:2-15-01 Referenced standards: ~~70-14 National Electrical Code~~ 70-17 National Electrical Code (Ohio Mechanical Code)

4101:3-13-01 Referenced standards: ~~70-14 National Electrical Code~~ 70-17 National Electrical Code (Ohio Plumbing Code)

preferably on January 1st, 2017.

It is a fact that the electrical industry is constantly changing and growing and will continue to do so at a rapid pace. With or without Ohio's adoption of the 2017 NEC, manufacturers, vendors, designers and installers will continue to employ the very latest and best in electrical technology.

Without adoption of the most up to date edition of the NEC, electrical inspectors cannot address many of these emerging technologies. Without adoption of the most up to date edition of the NEC, property owners cannot benefit from rule changes that often reduce cost and provide other benefits. When electrical inspectors cannot use the most current Standard for their inspections the public safety suffers.

Late adoption is a relatively new problem in Ohio, a problem that is getting worse instead of better. In recent years electrical inspectors have been tasked with

enforcing two editions of the NEC for a significant portion of a given code cycle – one edition being applied to OBC work and another edition being applied to RCO work.

There have been many projects where a builder is building 3-family dwellings beside 4-family dwellings; with the 3-family dwelling and the 4-family dwelling each subject to different editions of the NEC!

Unfortunately, the buildings where most Ohioans sleep (*trusting that the very latest and best in code adoption and enforcement is protecting their family*) – 1, 2, and 3-family dwellings - are usually the last in line to benefit from timely adoption of the NEC because of the intense lobbying that goes on to delay code adoption. Special interests - HBA is an excellent example - secure appointments to boards and committees that regulate building code adoption. The current process is for the appointees to wait until the exhaustive technical processes of the NEC code panels are completed before they stop adoption with political power. We have seen firsthand where the value of NFPA's exhaustive technical process is totally ignored by a board top-heavy with outside interests. What follows is either a delay in adoption or worse: portions of the NEC deleted or modified by these "experts". The special interests are the "winners". The public safety is the "loser". There is serious change needed in the code adoption process.

There was a time not too many years ago when Ohio led the way in electrical safety by adopting the most current edition of the NEC for ALL occupancies, usually in January of the year it was released. The OBBS fails the public safety when it helps to delay instead of promote timely adoption of the NEC. Special interest groups and financial interests appear to have the "ear" of the Board more than ever before and public safety suffers every day that adoption is delayed.

We encourage you to promote electrical safety for all Ohioans by returning to the methods employed in the past that enabled timely adoption of the latest edition of the NEC for use as the referenced standard in the OBC and RCO.

Very truly yours,

A handwritten signature in black ink, appearing to read "Gaylord Poe". The signature is fluid and cursive, with a prominent initial "G" and "P".

Gaylord Poe, President



"Let the Code Decide"
OHIO CHAPTER
International Association of
Electrical Inspectors

President

Cathryn Robinson
Southwest Division

October 18, 2016

First Vice-President

Calvin Beverly
Akron Division

Ohio Board of Building Standards
6606 Tussing Road.
Reynoldsburg, Ohio 43068
Attention: Regina Hanshaw, Executive Secretary

Second Vice-President

Michael Koken
Eastern Division

RE: 2017 NEC Adoption

Dear Regina Hanshaw and Ohio Board of Building Standards,

Immediate Past-President

Jerald Gerber
Western Reserve Division

I am writing this letter on behalf of the Ohio Chapter IAEL. The Ohio Chapter IAEL is in complete support of the quick and timely adoption of the NEC 2017 Edition. Electrical safety for Ohio citizens is paramount and the quick and timely adoption of the NEC 2017 Edition will aid in the electrical safety for all Ohio citizens.

Secretary/Treasurer

Lorenzo Adam
Southwest Division

Technology is forever advancing and this new technology is being installed in homes and buildings all over this State. Our Standards of electrical safety for installations and inspections should keep up with this ever changing technology to ensure the electrical safety for the citizens of Ohio in their homes and all buildings that they enter.

Inspector Member

Karl Frederick
Central Division

The NFPA works diligently to create a new Edition every three years. This is a collaborate effort with electrical industry manufacturers, national recognized testing labs like UL, design professionals, inspectors and installers from all over the country. These are the groups and individuals that know the electrical industry inside and out. All of these groups and individuals work for the betterment of electrical safety and through the NEC 2017 Edition has created a Standard that will offer the safest electrical installation to date.

Inspector Member

Zach Jenkins
Northwest Division

It may be the opinion of some on the OBBS that this new standard is not needed at this time but it is the opinion of the Ohio Chapter IAEL Board, its members statewide, and the Ohio electrical industry that it is gravely needed and needed in a quick and timely manner. It is needed to ensure the greatest level of safety of all Ohio Citizens.

Inspector Member

Kenneth Bolyard
West Virginia Division

Inspector Member

Joseph Cenzori
Western Reserve Division

Thank You,

Associate Member

Ronald F. Schapp
Southwest Division

Caty Robinson
President
Ohio Chapter IAEL

Western Section

Chapter Representative

Jeff Grassi
Western Reserve Division

Membership Chairman

Joseph Cenzori
Western Reserve Division

Education Chairman

Gaylord Poe
Southwest Division

Historian

Kenneth Bolyard
West Virginia Division



National Fire Protection Association

Tim McClintock
Regional Electrical Code Specialist
11813 Township Road, Shreve, Ohio, 44676, USA
TEL: +1 330-567-2030 CELL: +1 330-749-9782 Email: tmccclintock@nfpa.org

October 19, 2016

Ms. Regina Hanshaw
Executive Secretary
Ohio Board of Building Standards
6606 Tussing Rd
Reynoldsburg, OH 43068

Re: Proposed updates to the Ohio Building, Plumbing and Mechanical Codes

Dear Ms. Hanshaw:

In response to the Ohio Board of Building Standards Stakeholder notification requesting comment to proposed updates to the Ohio Building, Mechanical and Plumbing Codes, I respectfully request the OBBS include updating the NFPA 70 from the 2014 edition to the 2017 edition as part of that rule package update. This would include updating the following OAC Sections:

4101:1-35-01 Referenced standards: ~~70-14 National Electrical Code~~ 70-17 National Electrical Code (Ohio Building Code)

4101:2-15-01 Referenced standards: ~~70-14 National Electrical Code~~ 70-17 National Electrical Code (Ohio Mechanical Code)

4101:3-13-01 Referenced standards: ~~70-14 National Electrical Code~~ 70-17 National Electrical Code (Ohio Plumbing Code)

NFPA 70 focuses on the proper installation of electrical systems and equipment to protect people and property from hazards arising from the use of electricity. As electrical equipment has become more complex and widespread, the NFPA 70 has adapted to meet new challenges. Revised every three years to allow for new technologies and improved installation safety practices, NFPA 70 is a ready-to-use, comprehensive standard suitable for adoption.

NFPA 70 is developed and produced by the National Fire Protection Association (NFPA), an independent, not-for-profit standards developing organization and advocate of fire, building, and electrical safety. Since 1911, NFPA has been the sponsor of NFPA 70 and the requirements of this standard have continued to evolve with America's heavy reliance on reliable and safe electrical energy. NFPA 70 is developed through an open, transparent, and balanced process accredited by the American National Standards Institute.

The NFPA 70 community has worked diligently to make sure safe installation rules are in place for the continuously changing electrical industry landscape. The 2017 edition of NFPA 70 was issued

by the NFPA Standards Council on August 4, 2016 and was approved as an American National Standard on August 24, 2016.

In addition to advancement of new methods and installation practices, new requirements for utility-scale PV systems, direct-current microgrids and energy storage systems are included in the 2017 NFPA 70 and are examples of the regulatory piece trying to keep up with the innovation piece.

These are exciting times for the electrical industry as we transition from centralized utility supplied electricity to on-site generation, distribution and storage. Timely adoption of the 2017 NFPA 70 will ensure we don't hamstring innovators, installers and most importantly the regulators with respect to advancements in technology and innovation.

Sincerely,

A handwritten signature in black ink that reads "Tim McClintock". The signature is written in a cursive style with a large initial "T" and "M".

Tim McClintock
Regional Electrical Code Specialist
National Fire Protection Association
Office: 330-567-2030
Cell: 330-749-9782
tmcclintock@nfpa.org



KYLE PITSOR

Vice President, Government Relations

October 20, 2016

Ms. Regina Hanshaw
Executive Secretary
Ohio Board of Building Standards
6606 Tussing Road
Reynoldsburg, OH 43068

Re: NEMA Supports Adoption of 2017 Edition of the National Electrical Code

Dear Ms. Hanshaw:

In response to the Ohio Board of Building Standards Stakeholder notification requesting comment to proposed updates to the Ohio Building, Mechanical and Plumbing Codes, I respectfully request the OBBS include updating the NFPA 70 from the 2014 edition to the 2017 edition as part of that rule package update. This would include updating the following OAC Sections:

4101:1-35-01 Referenced standards: 70-14 National Electrical Code 70-17 National Electrical Code (Ohio Building Code)

4101:2-15-01 Referenced standards: 70-14 National Electrical Code 70-17 National Electrical Code (Ohio Mechanical Code)

4101:3-13-01 Referenced standards: 70-14 National Electrical Code 70-17 National Electrical Code (Ohio Plumbing Code)

On behalf of the National Electrical Manufacturers Association (NEMA), I am writing to express support to update the 2014 edition of NFPA 70 (National Electrical Code®) to the 2017 edition of NFPA 70. For many years, Ohio has championed the standard of excellence by being one of the first states in the nation to adopt the newest edition of the National Electrical Code® – putting the safety of its citizens and economic well-being of its industry first.

NEMA is the trade association of choice for the electrical equipment and medical imaging manufacturing industry. The approximately 400 member companies manufacture products used in the generation, transmission and distribution, control, and end-use of electricity. NEMA member companies have a significant presence in the state of Ohio representing 27 companies with 145 manufacturing and engineering facilities that support the state's economy. Member companies in Ohio collectively employ over 21,357 state residents.

NEMA has long supported timely adoption of the National Electrical Code® (NEC) by state and local jurisdictions. We maintain that prompt adoption of the most current edition of the NEC is

National Electrical Manufacturers Association
1300 North 17th Street, Suite 900 - Rosslyn, VA 22209

the best way to ensure a uniform and up-to-date standard of safety for all occupants in the built environment. Current codes mean safer and more economically prosperous communities.

The NEC focuses on the proper installation of electrical systems and equipment to protect people and property from hazards arising from the use of electricity in the built environment. The code also allows for the safe use of new technologies including electric vehicle charging equipment and distributed generation such as solar photovoltaic panels.

Through adoption of the 2017 NEC, businesses today will be able to take advantage of lower infrastructure start-up and operational costs through new and improved technology. For instance, Article 691 Large-Scale Photovoltaic (PV) Electric Supply Stations - addresses requirements for large scale PV systems of no less than 5000 kW. Article 712 Direct-Current Micro-grids - New requirements to address micro-grids as they are becoming popular and are a means to increase energy efficiency, reduce costs, and maintain critical business continuity.

Once again, NEMA urges the OBBS to maintain this tradition of excellence by adopting the 2017 edition of the National Electrical Code®. If you have any questions, please contact Don Iverson (don.iverson@nema.org) or 517-628-2505.

Sincerely,



Kyle Pitsor
Vice President, Government Relations



727 Lime City Road, Suite 100 Rossford, OH 43460

October 20, 2016

Ohio Board of Building Standards
6606 Tussing Rd.
Reynoldsburg, OH 43068

Attn: Regina Henshaw, Executive Director

Dear Regina Henshaw and esteemed members of the Board,

The Ohio/Michigan Chapter of NECA Board of Directors have asked me to draft this letter of recommendation on our Chapters behalf regarding the following:

RE: 4101:1-35-01 Referenced standards: ~~70-14 National Electrical Code~~ 70-17 National Electrical Code (Ohio Building Code)

4101:2-15-01 Referenced standards: ~~70-14 National Electrical Code~~ 70-17 National Electrical Code (Ohio Mechanical Code)

4101:3-13-01 Referenced standards: ~~70-14 National Electrical Code~~ 70-17 National Electrical Code (Ohio Plumbing Code)

We support the changes to the Ohio Building Code incorporating NFPA 70- 2017 Edition of the National Electrical Code as proposed by the petition submitted by the Ohio Electrical Code Coalition.

Timely adoption of the new NEC Code changes will help promote safety for installers and customers. It also helps the state of Ohio keep pace with changes in technology and safety enhancements. New requirements have been added to help communities accomplish the goal of making buildings safer, energy efficient, and reliable in the event of emergencies or disasters. Advancement of technology requires up to-date standards for safe implementation, to ensure that the end-user can take advantage of this innovation without endangering themselves, others, or their property.

Revised requirements covering the expanding use of solar photovoltaic power, to further increase first responder safety performing operations on a roof and to specify performance requirements for rapid shutdown protections. This is vital for our firefighting community and an area that they are fully in support of seeing implemented.

These are exciting and changing times for the electrical industry as we transition from centralized utility supplied electricity to on-site generation, distribution and storage. Timely adoption of the 2017 NEC will ensure we do not restrict

Ohio Board of Building Standards

6606 Tussing Rd.

Reynoldsburg, OH 43068

Regina Henshaw, Executive Director and esteemed members of the Board.

In response to the Ohio Board of Building Standards Stakeholder notification requesting comment to proposed updates to the Ohio Building, Mechanical and Plumbing Codes, I respectfully request the OBBS include updating the NFPA 70 from the 2014 edition to the 2017 edition as part of that rule package update. This would include updating the following OAC Sections:

4101:1-35-01 Referenced standards: (70-14 National Electrical Code) to the 70-17 National Electrical Code (Ohio Building Code)

4101:2-15-01 Referenced standards: (70-14 National Electrical Code) to the 70-17 National Electrical Code (Ohio Mechanical Code)

4101:3-13-01 Referenced standards: (70-14 National Electrical Code) to the 70-17 National Electrical Code (Ohio Plumbing Code)

Updating to the 2017 NEC is a vitally important and a proactive step for the economic savings, consumer protection and the safety advancements of new electric system technology. Using and referencing the most current codes and standards is necessary for a progressive state and its citizens to keep pace with changes to technology and safety enhancements.

Up-to-date safety standards promote the use of new technology, which has immeasurable societal benefits from an economic perspective. Additionally, this helps to promote and spur new business opportunities and economic growth for Ohio and its citizens.

New requirements have been added to help communities accomplish the goal of making buildings safer, more energy efficient, and reliable in the event of disasters or emergencies. Advancement of technology requires up to-date standards for safe implementation, to ensure that the end-user can take advantage of these innovations without endangering themselves, others, or their property.

Code development includes stakeholders from all facets of society and the National Electrical Code Panels are made up of individuals who represent all interests of the manufacturing, safety, electrical, and construction industries. Their collected experience and expertise are utilized in the formation and adoption of the most current codes and standards.

The citizens of Ohio deserve and expect the best that is offered for their homes, occupations, places we work at, worship at, play and entertain. The intent of the National Electrical Code is the 'practical safeguarding of persons and property from the hazards arising from the use of electricity'. All of the changes and new technology that we are witnessing require proper installation and safety requirements found in the most current code. They need to be adopted and utilized for the protection of the public.

We need to do all that we can to accomplish that.

Respectfully submitted,

Michael J Farrell 

Michael J. Farrell III

Building/Electrical Inspector

Lucas County Building Regulation

Member of IAEI, IBEW, ICC, NFPA, OBOA

Secretary/Treasurer

Northwest Division

OHIO Chapter IAEI



CENTRAL OHIO CHAPTER, NECA, INC.

Brian D. Damant, Chapter Manager
P. O. Box 163128
Columbus, Ohio 43216-3128

Phone: 614-224-4408
Fax: 614-224-1847
E-mail: b.damant@electricaltrades.org

October 27, 2016

Ms. Regina Hanshaw, Executive Secretary
Ohio Board of Building Standards
6606 Tussing Rd.
Reynoldsburg, OH 43068

Dear Ms. Hanshaw,

We understand the Ohio Board of Building Standards has on its October 28, 2017 agenda the consideration for adoption of revisions to the Ohio Building, Mechanical and Plumbing Codes. Please be advised the Board of Directors of the Central Ohio Chapter, NECA, Inc. respectfully request that the OBBS amend their proposal to include the NFPA 70-17 edition rather than the NFPA 70-14 edition of the National Electrical Code. The proposal should be amended as follows:

4101:1-35-01 Referenced standards: ~~70-14 National Electrical Code~~ 70-17 National Electrical Code (Ohio Building Code)

4101:2-15-01 Referenced standards: ~~70-14 National Electrical code~~ 70-17 National Electrical Code (Ohio Mechanical Code)

4101:3-13-01 Referenced standards: ~~70-14 national electrical Code~~ 70-17 National Electrical Code (Ohio Plumbing Code)

Please thank the Ohio Board of Building Standards for their consideration of our request.

Sincerely,

Brian Damant

CC: COHNECA Board of Directors

Hanshaw, Regina

From: Brian Damant <B.Damant@electricaltrades.org>
Sent: Friday, October 21, 2016 1:22 PM
To: BBS, BBSOfficAsst3
Subject: error

Attention Regina Hanshaw, Executive Secretary, OBBS

I would like to bring to your attention an error in the OBBS proposal. Specifically there is language missing in Section 104.2.3.4.2. This section addresses who conducts the inspections when a Fire Protection Inspector is not employed or retained. Parts of the last sentence of this section have been inadvertently left out. Obviously this error should be corrected.

Brian Damant, Chapter Manager
Central Ohio Chapter, NECA, Inc.
614 224 4408

Hanshaw, Regina

From: Paul Kowalczyk <pkowalczyk@pepperpike.org>
Sent: Friday, October 21, 2016 12:45 PM
To: Hanshaw, Regina; Ohler, Debbie
Subject: New Codes

Regina and Debbie,

Is the BBS planning on any training for the 2012 IECC?

In the Referenced Standards of the I-codes, they include the applicable code sections for cross referencing. When Ohio adopts new codes the cross referencing of sections in this chapter is dropped. Is it possible to keep the cross reference sections in? This would greatly help out when determining whether or not the referenced standard is properly being used (a good resource for plans examiners).

Paul Kowalczyk

Hanshaw, Regina

From: Critty Buenconsejo <cbuenconsejo@creativehousing.org>
Sent: Tuesday, November 01, 2016 2:35 PM
To: Ohler, Debbie; Hanshaw, Regina
Cc: BBS, BBSOfficAsst3
Subject: OBC 10.28.16 Stakeholder Meeting_Comments_16-1101

Thank you for taking the time to listen to our questions/concerns last Friday.

I'd like to start with a summary of concepts taken away from the meeting for a baseline to our comments. Please correct me, if the brief recap has inaccurate information.

- The Occupancy Classification Matrix of Care Facilities eliminated the “step” between Custodial and Medical Care: Custodial Care <= 5, Incapable of Self Preservation
- Licensure requirements are “omitted” from OBC requirements and shall be considered a “bonus” related to required measures that would provide safety features in addition to the building code.
 - Having home care staff on site that would help with evacuation is irrelevant with regards to the building code.
- Proposed Occupancy Classifications are intended to provide for building safety measures specific to “new” types of occupancies.
- As the proposed language reads, occupancy type changes as a person’s health changes related to need for Custodial Care or Medical Care.
 - As a homeowner living at home, this would have no effect on building code requirements.
 - This is not currently differentiated in the proposed code.
 - As a renter of a home or apartment, the building owner may be responsible to make changes to the building as required based on the change of occupancy due to Custodial/Medical Care needs.
- Aging-In-Place or a life event creating a need for Custodial/Medical Care or creating an inability to self-evacuate at a rental home/apartment would trigger change of occupancy.
 - A tenant may be considered in violation of their lease, if continuing to live in a “normal residential” unit after Medical Care becomes necessary.
- An owner/landlord would have the option to upgrade the unit to accommodate relevant codes, or not lease to persons that would trigger such Occupancy Classifications.
- Local building departments would be dependent on residential building owners to provide notification of the Occupancy Change, triggering relevant upgrades.

As a reminder, our comments are not specific to the Developmentally Disabled population, but to the general population of Ohio.

Code impact for consideration:

1. 24-Hour Basis Definition/Qualification
 - a. Our tenants are not in our homes/apartments for the purpose of receiving care. They are in the homes for the purpose of living in a home environment like “everyone else” – it just so happens that some tenant may need assistance equating to Custodial Care.
 - i. This ties back to the concepts of one’s grandparents who need custodial care having difficulty finding a place to rent because it does not have sprinklers.
 - b. Our tenants are not necessarily “homebound” within a facility for 24 hours, as many of them either work or attend day programs.

2. Broad Nature of Custodial Care Definition
 - a. Degree of Custodial Care varies, as some persons may only need assistance a few hours a week, while others may need significantly more.
 - b. It appears the term Custodial Care may be used to accommodate care provided in licensed group homes or other such facilities that are under the purview of government agencies (e.g. via licensure).
 - c. The definition is inclusive of occupants in non-licensed facilities and would have implications on building owners that have no relationship/interaction with care providers nor knowledge of individual health conditions at any given time.
 - d. The broad nature of the definition as it relates to the proposed code creates an unusual burden on building owners & tenants.
 - i. As the responsible party, owners would need to have occupants release HIPPA information to them or for the owner to make non-qualified assessments of services rendered to occupants and/or occupant health status.
 - ii. As the lessee, an occupant would need to report health/care changes to an owner.

3. Broad Nature of Medical Care Definition
 - a. What is included in “medical or surgical procedures?”
 - b. I would assume that excluded are routine care that does not require a nurse/nurse practitioner like:
 - i. Some types of trachea suctioning, G-tube for feeding, assistance with taking medications
 - c. If a nurse/nurse practitioner gives occupants their Insulin injections, does this kick into Medical Care?
 - d. What about medical procedures that are only needed temporarily?

4. Code Awareness of Building Owners
 - a. Commercial apartment buildings are different than single-family home rentals
 - b. Independent landlords who may own one or a few rental homes (one, two, or three-family) are typically not as code-savvy as commercial building owners
 - i. They would not be aware of the significant impact of these code changes on existing homes based on renter/occupant status changes.
 - c. Building Owners may not be financially able to retrofit existing properties for the sprinkler requirement, thereby unable to rent to those falling under new occupancy classifications.

We request that the BBS consider the wide-spread ramifications of the proposed occupancy-related code changes. New construction is one thing, but the concept of a requirement to retrofit existing residential construction based on a change of use due to care needs is a daunting one. The effect may be a significant reduction in an already limited availability of homes appropriate for those needing accessibility/special care. And the need for such homes will continue to increase as federal regulations are both encouraging and requiring persons to live in a home setting as cost-containment efforts related to health care services.

We understand the BBS’ charge of building safety and request that a balance between safety measures, financial burdens and federal regulations be maintained.

With regards to fire safety, perhaps an alternate to 13D sprinklers might put in place for the <=5 occupant homes such as the installation of a residential hood suppression system based on data that may show a majority of residential fires result from cooking. We have also installed automatic stove shut-offs that turn a stove off when the device senses that someone is not attending to the stove for a certain amount of time. A monitored fire notification system may also be a reasonable option.

With regards to a building owner needing to know one’s care needs, this may cause challenges based on rights to privacy, HIPPA, etc. We suggest code based on care needs as it relates to residential settings be considered very carefully.

Obviously, further discussion would be beneficial. Please don't hesitate to contact me with any specific questions or concerns prior to the next Stakeholder meeting.

Respectfully,

Cristy "Critt" Buenconsejo
Dir. of Projects & Design

Creative Housing | Creative Renovations
2233 Citygate Dr.
Columbus, OH 43219

614.418.7725 x26 o
614.554.0326 c

creativehousing.org
accessibilityrenovations.org

Hanshaw, Regina

From: David Collins <dcollins@preview-group.com>
Sent: Monday, October 31, 2016 2:04 PM
To: Hanshaw, Regina
Subject: Re: November 4 Board Meeting

Regina,

Were there changes based on the stakeholder meetings?

I have been postulating on what we can do to address the issue of R-3 Care and thought it would be good to discuss at the Codes Committee meeting on Thursday. What I am focusing on is perhaps inserting something like "providing custodial care". So, if the owner is simply providing housing, for 5 or fewer, they would be classified as an R-2, if the owner is providing custodial care and are capable or incapable of self preservation , then they are classified as R-3. Then 308.3.4 would look like this:

308.3.4 Five or fewer persons receiving custodial care. *A facility with five or fewer persons providing custodial care to five or fewer persons shall be classified as Group R-3 or shall comply with the "Residential Code of Ohio for One-, Two-, or Three- Family Dwellings" provided an automatic sprinkler system is installed throughout the fire area in accordance with Sections 903.3.1.1, 903.3.1.2, 903.3.1.3, or Section 2904 of the "Residential Code of Ohio for One-, Two-, or Three- Family Dwellings."*

I began looking at all the definitions of where care is provided and each has the language that the facility or building where care is provided, except for custodial care.

AMBULATORY CARE FACILITY. Buildings or portions thereof used to provide medical, surgical, psychiatric, nursing or similar care on a less than 24-hour basis to individuals who are rendered incapable of self-preservation by the services provided.

CLINIC, OUTPATIENT. Buildings or portions thereof used to provide medical care on less than a 24-hour basis to persons who are not rendered incapable of self-preservation by the services provided.

CUSTODIAL CARE. Assistance with day-to-day living tasks; such as assistance with cooking, taking medication, bathing, using toilet facilities and other tasks of daily living. Custodial care includes persons receiving care who have the ability to respond to emergency situations and evacuate at a slower rate and/or who have mental and psychiatric complications.

CLINIC, OUTPATIENT. Buildings or portions thereof used to provide medical care on less than a 24-hour basis to persons who are not rendered incapable of self-preservation by the services provided.

DETOXIFICATION FACILITIES. Facilities that provide treatment for substance abuse, serving care recipients who are incapable of self-preservation or who are harmful to themselves or others.

FAMILY DAY-CARE HOME, TYPE A. A home where the administrator permanently resides and where care is provided for seven to twelve children under six years of age or four to twelve children when at least four are under two years of age. Licensure is required of these homes by the Ohio Department of Job and Family Services when at least one of the children cared for is not a sibling of the others and the home is not the permanent residence of the children. These homes are also referred to as Type A Homes and Type A Child Care and are exempt from the rules of the board. Also see Chapter 5104. of the Revised Code

FAMILY DAY-CARE HOME, TYPE B. A home where the administrator permanently resides and where care is provided for one to six children under six years of age with no more than three children under two years of age when at least one of the children cared for is not a sibling of the others and the home is not the permanent residence of the children. These homes are also referred to as Type B Homes and Type B Child Care and are exempt from the rules of the board. Also see Chapter 5104. of the Revised Code.

FOSTER CARE FACILITIES. Facilities that provide care to more than five children 2 ½ years of age or less.

I am thinking that if we fix 308.3.4 by saying a facility providing ... and change the definition to say:

CUSTODIAL CARE. A facility providing assistance with day-to-day living tasks; such as assistance with cooking, taking medication, bathing, using toilet facilities and other tasks of daily living. Custodial care includes persons receiving care who have the ability to respond to emergency situations and evacuate at a slower rate and/or who have mental and psychiatric complications.

Then it is the facility and the owner must know that they are doing this as in every other type of care!

Dave

From: Regina.Hanshaw@com.state.oh.us <Regina.Hanshaw@com.state.oh.us>

Sent: Friday, October 28, 2016 7:11 PM

To: 'scoop494@aol.com'; 'Tim.Galvin@brextonllc.com'; David Collins; 'Joe Denk' (jdenk@denkassoc.com); 'John Johnson'; 'Don Leach'; 'TMcCafferty@pipefitters120.org'; 'don.mcilroy@ci.circleville.oh.us';

'Christopher.Miller@icemiller.com'; 'jpavlis@neo.rr.com'; 'jeff@jzcompanies.com'; 'scholz.doug@unibilt.com'; 'Schultz, Carl (carl.schultz@aecom.com)'; Manning, Shayne (SManning@thpltd.com); abstanbery@abstanberyinc.com

Cc: felecia.jackson@com.state.oh.us; Steven.Regoli@com.state.oh.us; debbie.ohler@com.state.oh.us; robert.johnson@com.state.oh.us; Michael.Regan@com.state.oh.us; Michael.Lane@com.state.oh.us;

Hanshaw, Regina

From: Pete Baldauf <pbaldauf@vandaliaohio.org>
Sent: Friday, October 21, 2016 10:55 AM
To: Regoli, Steve
Cc: Hanshaw, Regina; Gaylord Poe (gpoe@inspectionbureau.com)
Subject: 102.10 and 104.2.2.1.2
Attachments: 102 10 rework.docx; Fire_Alarm_Systems_2014NEC.pdf; NPLFA - NEC.pdf

Steve,

Thanks for the call and the good conversation yesterday. After speaking with you I have a better understanding of what is driving the proposed addition to the OBC. As I said, I feel it's a matter of education for the inspector(s) and/or building department(s) instead of a new rule. After all, if they don't understand the rules that are in place now I'm not sure adding more rules will clarify the matter for them. Anyhow, Gaylord and I have collaborated efforts on new wording for 102.10 (see attachment) that I think will get the "point" across and more clearly define what we have the authority to inspect and approve.

You and I also spoke about the additional wording added to 104.2.2.1.2. As you know, I am of the opinion that the change isn't necessary. I can't think of a more qualified person than an EPE to review the electrical portion of a fire alarm system. We discussed low voltage fire alarm systems (power limited) but, as you know, those are not the only type of fire alarm system. There are also non-power limited systems (line voltage) that are used. They are not as common as the power limited systems but they do exist and they are still permitted to be installed.

The proposed addition to 104.2.2.1.2 would prohibit the EPE from reviewing the non-power limited systems as well. Again, I think that educating building departments and the EPE's on how the building code intends for reviews to be conducted would be more beneficial than essentially removing a qualified individual from the review process of fire alarm systems altogether.

Since I will not be able to attend the stakeholders meeting I would certainly appreciate it if you could bring up these points for discussion and consideration.

I have also copied and pasted an e-mail from Gaylord to me (see below). I think he offers even better and more technical reasons that an EPE should be involved in the review process for fire alarm systems.

Hello Pete,

Thank you for the update on your conversation with Steve yesterday. He's a good friend and always very helpful. You asked for my opinion on a couple of things you discussed. Once you review this if you think I should write a letter to Regina to be included as comments to the upcoming Stakeholders Meeting I will be happy to do so. Just let me know.

- Regarding you saying "their" reason for the new verbiage in 104.2.2.1.2 "*For the purposes of this section, electrical systems do not include fire alarm systems.*" is because it's "low voltage", I'm saying that is just incorrect. I wish those guys reading **102.10 Electrical: 4.** in the OBC would actually read it and understand what it says! There's not a period after twenty-five volts! The first part of the paragraph is about voltage AND wattage ("VA" these days) not one or the other! This is frustrating because I've had this same conversation over and over and over (last round being with Robert Johnson!!) for years. The rule says "*...operating at less than twenty-five volts and not capable of supplying more than fifty watts of energy, unless specifically addressed in this code.*" So in view of the text, there's a lot wrong with calling a fire alarm system "just low voltage" and walking

away from it. Doing so violates the OBC (and public safety) in several ways: *because* fire alarm systems can be line voltage (Non-power limited “NPLFA” – up to 600V) or low voltage (power limited “NPLFA” – far exceeding 50 watts); the low voltage power-limited systems we see on fire alarm installations supply a minimum 100 watts per FA circuit (twice the OBC threshold); and what is even more concerning is even if the systems fell below the voltage AND wattage thresholds they are still “...specifically addressed in this code.” in 106.1.1. So when I read this proposal I’m thinking “What the heck are these guys doing here?”

- One other thing (not my business) but while you were talking did the incomplete sentence at the end of **104.2.3.4.2** come up?

I hope you find my research helpful. Let me know if you think a letter from SW is needed!

GP

REFERENCES:

102.10 Electrical: 4. *Electrical wiring, devices, appliances, apparatus or equipment operating at less than twenty-five volts and not capable of supplying more than fifty watts of energy, unless specifically addressed in this code.*

104.2.2.1.2 Electrical plans examiner. *An electrical plans examiner is responsible for the examination of construction documents related to electrical systems to determine compliance with the rules of the board.*

If the department does not have in its employ or under contract persons holding the electrical plans examiner certification, then the examination of the construction documents for compliance with the electrical provisions of the code shall be done by the master plans examiner. For the purposes of this section, electrical systems do not include fire alarm systems.

104.2.3.4.2 Fire protection inspector. *A fire protection inspector is responsible to determine compliance with approved construction documents for fire protection systems (automatic sprinkler systems, alternative automatic fire-extinguishing systems, standpipe systems, fire alarm and detection systems, and fire pump) in accordance with section 108.*

If the department does not have in its employ or under contract persons holding the fire protection inspector certification, then the enforcement

106.1.1 Information on construction documents.

15. System descriptions. *Complete description of the plumbing, mechanical and electrical systems, including: materials, insulation “R”-values, general routing and sizes of all piping; location and type of plumbing fixtures and equipment; plumbing schematics and isometrics; materials, insulation “R”-values, general routing and sizes of all ductwork, vents, and louvers; location and type of heating, ventilation, air conditioning, and other mechanical equipment; location and type of all fire alarm, lighting and power equipment; type and size of all electrical conductors.*

Thank you!

Pete Baldauf
City of Vandalia
Electrical / Building Inspector
P: 937-415-2326
F: 937-415-2319
pbaldauf@vandaliaohio.org



6. Electrical equipment and the associated wiring on the load side of the power disconnect to the equipment for installations in and adjacent to natural or artificially made bodies of water as defined in Article 682 of NFPA 70 as referenced in Chapter 35.

Table 11(A) and Table 11(B)

For listing purposes, Table 11(A) and Table 11(B) provide the required power source limitations for Class 2 and Class 3 power sources. Table 11(A) applies for alternating-current sources, and Table 11(B) applies for direct-current sources.

The power for Class 2 and Class 3 circuits shall be either (1) inherently limited, requiring no overcurrent protection, or (2) not inherently limited, requiring a combination of power source and overcurrent protection. Power sources designed for interconnection shall be listed for the purpose.

As part of the listing, the Class 2 or Class 3 power source shall be durably marked where plainly visible to indicate the class of supply and its electrical rating. A Class 2 power source not suitable for wet location use shall be so marked.

Exception: Limited power circuits used by listed information technology equipment.

Overcurrent devices, where required, shall be located at the point where the conductor to be protected receives its supply and shall not be interchangeable with devices of higher ratings. The overcurrent device shall be permitted as an integral part of the power source.

Table 11(A) Class 2 and Class 3 Alternating-Current Power Source Limitations

Power Source	Inherently Limited Power Source (Overcurrent Protection Not Required)				Not Inherently Limited Power Source (Overcurrent Protection Required)			
	Class 2		Class 3		Class 2		Class 3	
Source voltage V_{max} (volts) (see Note 1)	0 through 20*	Over 20 and through 30*	Over 30 and through 150	Over 30 and through 100	0 through 20*	Over 20 and through 30*	Over 30 and through 100	Over 100 and through 150
Power limitations VA_{max} (volt-amperes) (see Note 1)	—	—	—	—	250 (see Note 3)	250	250	N.A.
Current limitations I_{max} (amperes) (see Note 1)	8.0	8.0	0.005	$150/V_{max}$	$1000/V_{max}$	$1000/V_{max}$	$1000/V_{max}$	1.0
Maximum overcurrent protection (amperes)	—	—	—	—	5.0	$100/V_{max}$	$100/V_{max}$	1.0
Power source maximum nameplate rating	VA (volt-amperes)	$5.0 \times V_{max}$	100	$0.005 \times V_{max}$	100	$5.0 \times V_{max}$	100	100
	Current (amperes)	5.0	$100/V_{max}$	0.005	$100/V_{max}$	5.0	$100/V_{max}$	$100/V_{max}$

Note: Notes for this table can be found following Table 11(B).

*Voltage ranges shown are for sinusoidal ac in indoor locations or where wet contact is not likely to occur.

For nonsinusoidal or wet contact conditions, see Note 2.

Mike Holt's Illustrated Guide to

ARTICLE 760— FIRE ALARM SYSTEMS

Based on the 2014 NEC

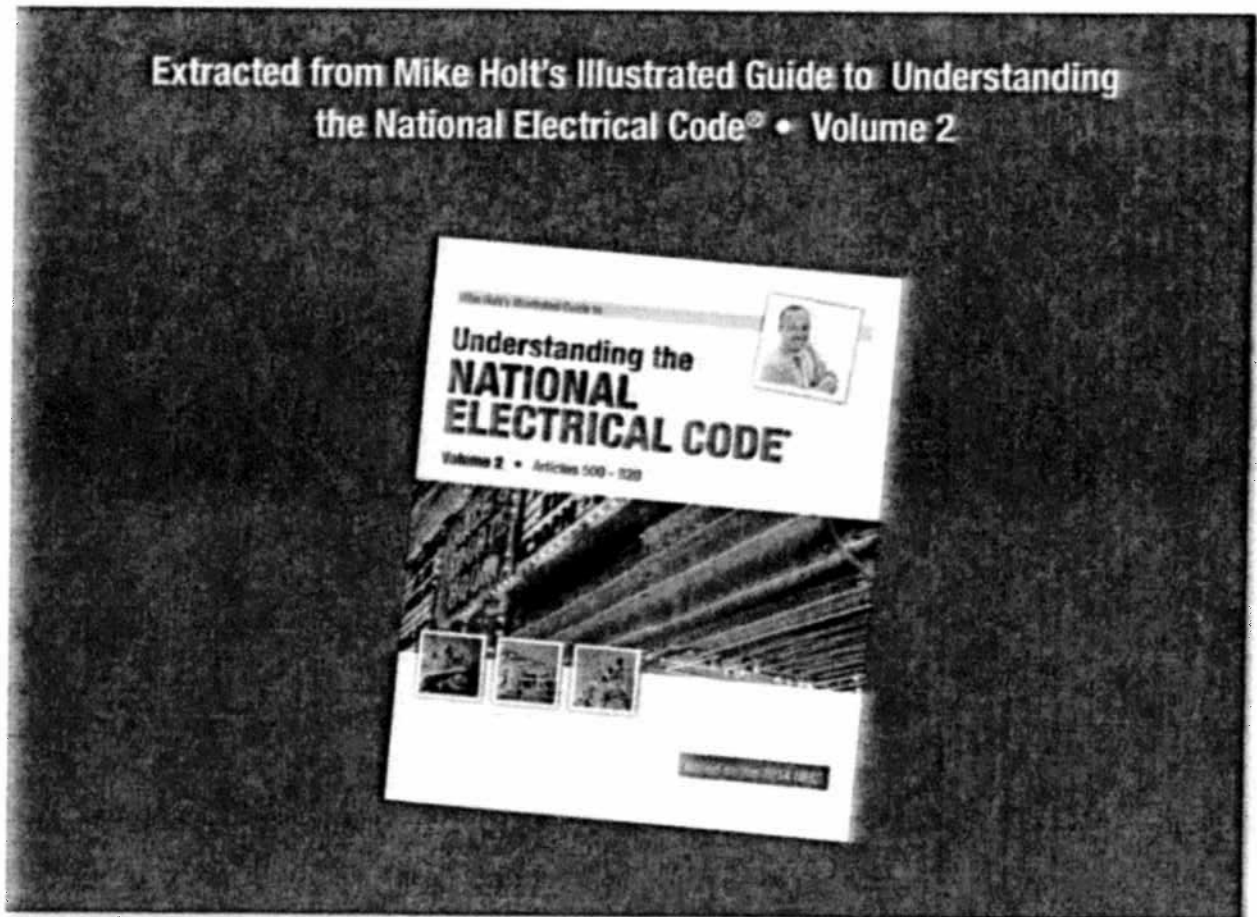

For more information on this or other training products,
visit www.MikeHolt.com or call 888.632.2633



Mike Holt Enterprises, Inc.
888.NEC.CODE (632.2633) • www.MikeHolt.com

Date: March 16, 2015

NOTICE TO THE READER

The publisher does not warrant or guarantee any of the products described herein or perform any independent analysis in connection with any of the product information contained herein. The publisher does not assume, and expressly disclaims, any obligation to obtain and include information other than that provided to it by the manufacturer.

The reader is expressly warned to consider and adopt all safety precautions that might be indicated by the activities herein and to avoid all potential hazards. By following the instructions contained herein, the reader willingly assumes all risks in connection with such instructions.

The publisher makes no representation or warranties of any kind, including but not limited to, the warranties of fitness for particular purpose or merchantability, nor are any such representations implied with respect to the material set forth herein, and the publisher takes no responsibility with respect to such material. The publisher shall not be liable for any special, consequential, or exemplary damages resulting, in whole or part, from the reader's use of, or reliance upon, this material.

Author: Mike Holt

Technical Illustrator: Mike Culbreath

COPYRIGHT © 2015 Charles Michael Holt



Produced and Printed in the USA

All rights reserved. No part of this work covered by the copyright hereon may be reproduced or used in any form or by any means graphic, electronic, or mechanical, including photocopying, recording, taping, or information storage and retrieval systems without the written permission of the publisher. You can request permission to use material from this text by either calling 888.632.2633, e-mailing Info@MikeHolt.com, or visiting www.MikeHolt.com.

For more information, call 888.NEC.CODE (632.2633), or e-mail Info@MikeHolt.com.

NEC[®], NFPA 70[®], NFPA 70E[®] and National Electrical Code[®] are registered trademarks of the National Fire Protection Association.



This logo is a registered trademark of Mike Holt Enterprises, Inc.

ABOUT THE AUTHOR

Mike Holt worked his way up through the electrical trade. He began as an apprentice electrician and became one of the most recognized experts in the world as it relates to electrical power installations. He's worked as a journeyman electrician, master electrician, and electrical contractor. Mike's experience in the real world gives him a unique understanding of how the *NEC* relates to electrical installations from a practical standpoint. You'll find his writing style to be direct, nontechnical, and powerful.



Did you know Mike didn't finish high school? So if you struggled in high school or didn't finish at all, don't let it get you down. However, realizing that success depends on one's continuing pursuit of education, Mike immediately attained his GED, and ultimately attended the University of Miami's Graduate School for a Master's degree in Business Administration.

Mike resides in Central Florida, is the father of seven children, has five grandchildren, and enjoys many outside interests and activities. He's a nine-time National Barefoot Water-Ski Champion (1988, 1999, 2005–2009, 2012–2013). He's set many national records and continues to train year-round at a World competition level (www.barefootwaterskier.com).

What sets him apart from some is his commitment to living a balanced lifestyle; placing God first, family, career, then self.

*I dedicate this book to the
Lord Jesus Christ,
my mentor and teacher.
Proverbs 16:3*



ARTICLE 760

FIRE ALARM SYSTEMS

Introduction to Article 760—Fire Alarm Systems

Article 760 covers the installation of wiring and equipment for fire alarm systems, including circuits controlled and powered by the fire alarm. These include fire detection and alarm notification, guard's tour, sprinkler waterflow, and sprinkler supervisory systems. NFPA 72, *National Fire Alarm Code* provides other fire alarm system requirements.

Part I. General

760.1 Scope

Article 760 covers the installation of wiring and equipment for fire alarm systems, including circuits controlled and powered by the fire alarm system. Figure 760-1

Fire Alarm Systems
760.1

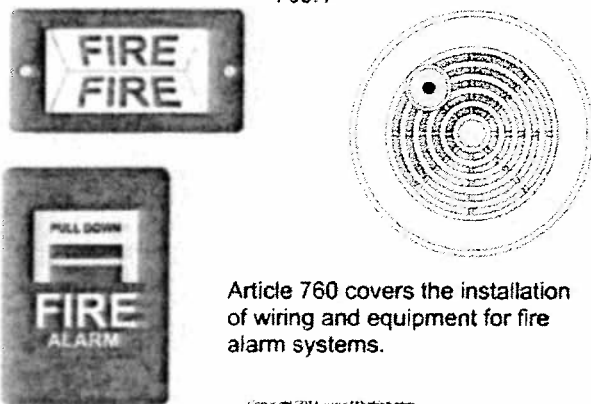

Figure 760-1

Author's Comment:

- Residential smoke alarm systems, including interconnecting wiring, aren't covered by Article 760, because they aren't powered by a fire alarm system as defined in NFPA 72.

Note 1: Fire alarm systems include fire detection and alarm notification, guard's tour, sprinkler waterflow, and sprinkler supervisory systems. Other circuits that might be controlled or powered by the fire alarm system include elevator capture, elevator shutdown, door release, smoke doors and damper control, fire doors and damper control, and fan shutdown.

NFPA 72, *National Fire Alarm and Signaling Code*, provides the requirements for the selection, installation, performance, use, testing, and maintenance of fire alarm systems.

Author's Comment:

- Building control circuits associated with the fire alarm system, such as elevator capture and fan shutdown, must comply with Article 725 [760.3(E)]. Article 760 applies if these components are powered and directly controlled by the fire alarm system.
- NFPA 101—*Life Safety Code* or the local building code specifies when and where a fire alarm system is required.

760.2 Definitions

Abandoned Fire Alarm Cable. A cable that isn't terminated to equipment and not identified for future use with a tag.

Author's Comment:

- Section 760.25 requires the accessible portion of abandoned cables to be removed.

Fire Alarm Circuit. The portion of the wiring system and connected equipment powered and controlled by the fire alarm system. Fire alarm circuits are classified as either nonpower-limited or power-limited.

Nonpower-Limited Fire Alarm Circuit. A nonpower-limited fire alarm circuit can operate at up to 600V, and the power output isn't limited [760.41 and 760.43]. Figure 760-2

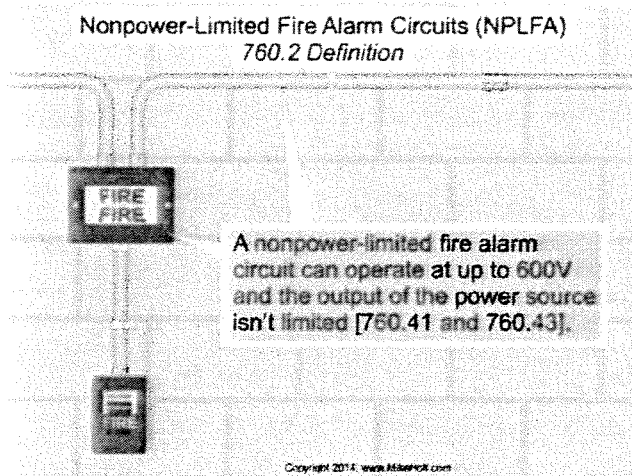

Figure 760-2

Power-Limited Fire Alarm Circuit. A power-limited fire alarm circuit must have the voltage and power limited by a listed power supply that complies with 760.121 as follows: Figure 760-3

Inherently Limited (ac) [Chapter 9, Table 12(A)]	
Voltage	Power
0V to 20V	5.00 x V
21V to 100V	100 VA

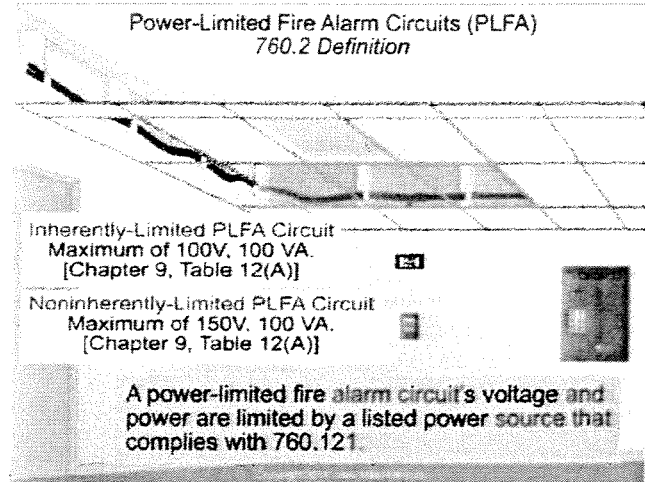

Figure 760-3

Not Inherently Limited [Chapter 9, Table 12(A)]		
Overcurrent Voltage	Power	Protection
0V to 20V	5.00 x V	5A
21V to 100V	100 VA	100V
101V to 150V	100 VA	1A

Author's Comment:

- Inherently limited power supplies are designed to burn out if overloaded.

760.3 Other Articles

Only those sections of Article 300 specifically referenced in this article apply to fire alarm systems, and fire alarm circuits and equipment must comply with (A) through (G) as follows:

(A) Spread of Fire or Products of Combustion. Fire alarm circuits installed through fire-resistant-rated walls, partitions, floors, or ceilings must be firestopped to limit the possible spread of fire or products of combustion in accordance with the instructions supplied by the manufacturer for the specific type of cable and construction material (drywall, brick, and so forth) [300.21]. Figure 760-4

Fire Alarm Cables - Fire-Rated Walls, Ceilings, and Floors
760.3(A)

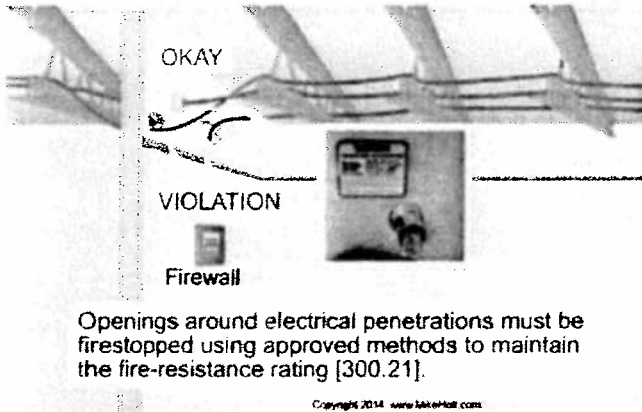

Figure 760-4

Openings around electrical penetrations must be firestopped using approved methods to maintain the fire-resistance rating [300.21].

Raceways or Sleeves Exposed to Different Temperatures
760.3(H)

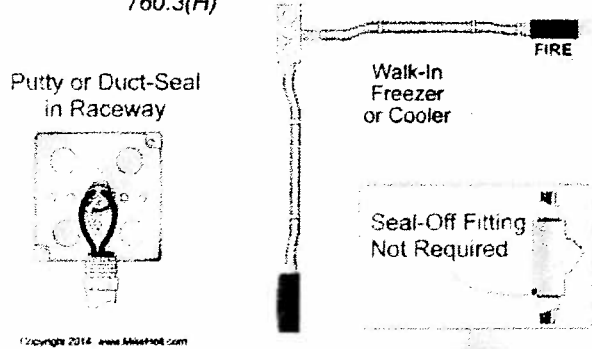

Figure 760-5

Raceways must be sealed to prevent the circulation of warm air to a colder section of the raceway or sleeve [300.7(A)].

(D) Corrosive, Damp, or Wet Locations. Fire alarm circuits installed in corrosive, damp, or wet locations must be identified for use in the operating environment [110.11], must be of materials suitable for the environment in which they're to be installed, and must be of a type suitable for the application [300.5(B), 300.6, 300.9, and 310.10(G)].

(E) Building Control Circuits. Class 1, 2, and 3 circuits used for building controls (elevator capture, fan shutdown, and so on), associated with the fire alarm system, but not controlled and powered by the fire alarm system, must be installed in accordance with Article 725 [760.1].

(F) Optical Fiber Cables. Optical fiber cables utilized for fire alarm circuits must be installed in accordance with Article 770.

(H) Raceways or Sleeves Exposed to Different Temperatures. If a raceway or sleeve is subjected to different temperatures, and where condensation is known to be a problem, the raceway or sleeve must be filled with a material approved by the authority having jurisdiction that will prevent the circulation of warm air to a colder section of the raceway. An explosionproof seal isn't required for this purpose [300.7(A)]. Figure 760-5

(J) Number and Size of Conductors in a Raceway. Raceways must be large enough to permit the installation and removal of conductors without damaging conductor insulation [300.17].

Author's Comment:

- When all conductors in a raceway are the same size and insulation, the number of conductors permitted can be found in Annex C for the raceway type.

Question: How many 18 TFFN fixture wires can be installed in trade size 1/2 electrical metallic tubing? Figure 760-6

- (a) 22 (b) 26 (c) 30 (d) 40

Answer: (a) 22 conductors [Annex C, Table C.1]

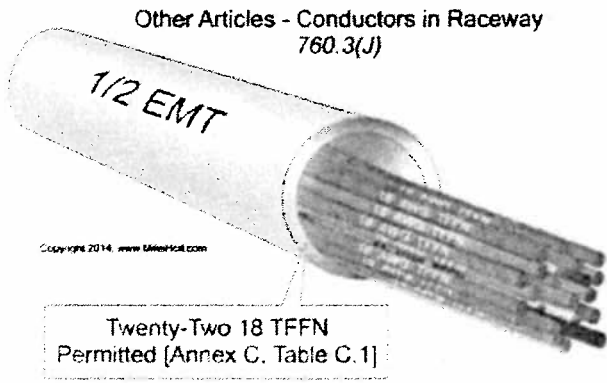

Figure 760-6

The number and size of conductors or cables in a raceway are limited in accordance with 300.17.

(K) Bushing. When a raceway is used for the support or protection of cables, a bushing to reduce the potential for abrasion must be placed at the location where the cables enter the raceway in accordance with 300.15(C). Figure 760-7

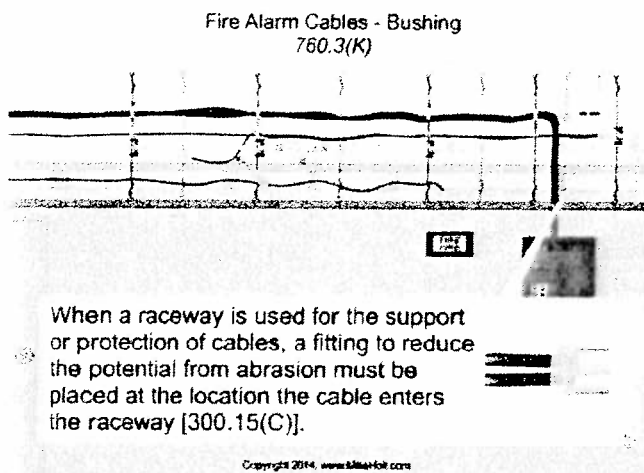

Figure 760-7

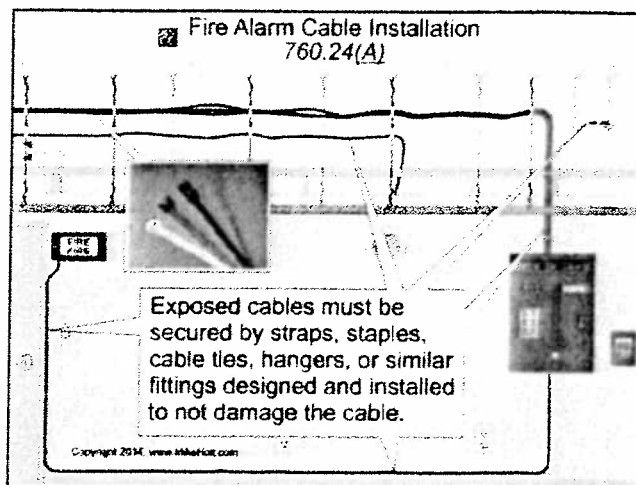

Figure 760-8

760.21 Access to Electrical Equipment Behind Panels Designed to Allow Access

Access to equipment must not be prohibited by an accumulation of cables that prevent the removal of suspended-ceiling panels.

Author's Comment:

- Cables must be located so that the suspended-ceiling panels can be moved to provide access to electrical equipment.

760.24 Mechanical Execution of Work

(A) General. Equipment and cabling must be installed in a neat and workmanlike manner.

Exposed cables must be supported by the structural components of the building so that the cable won't be damaged by normal building use. Cables must be supported by straps, staples, hangers, cable ties, or similar fittings designed and installed in a manner that won't damage the cable. Figure 760-8

Author's Comment:

- Raceways and cables above a suspended ceiling must be supported by independent support wires attached to the suspended ceiling [300.11(A), 760.46, and 760.130]. Figure 760-9

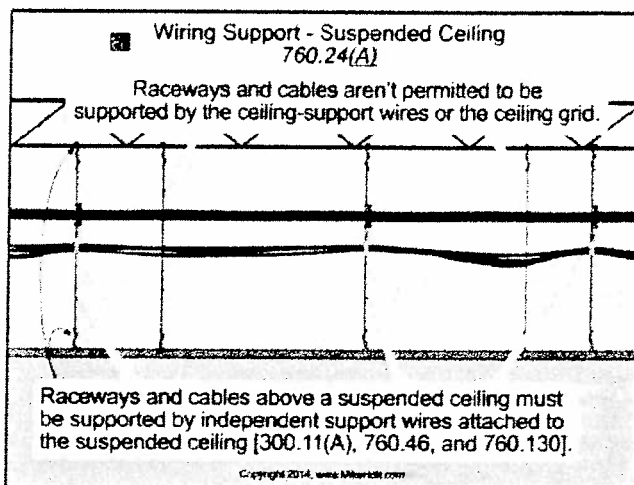

Figure 760-9

Cables installed through or parallel to framing members or furring strips must be protected where they're likely to be penetrated by nails or screws, by installing the wiring method so it isn't less than 1/4 in. from the nearest edge of the framing member or furring strips, or by protecting them with a 1/16 in. thick steel plate or the equivalent [300.4(D)]. Figure 760-10

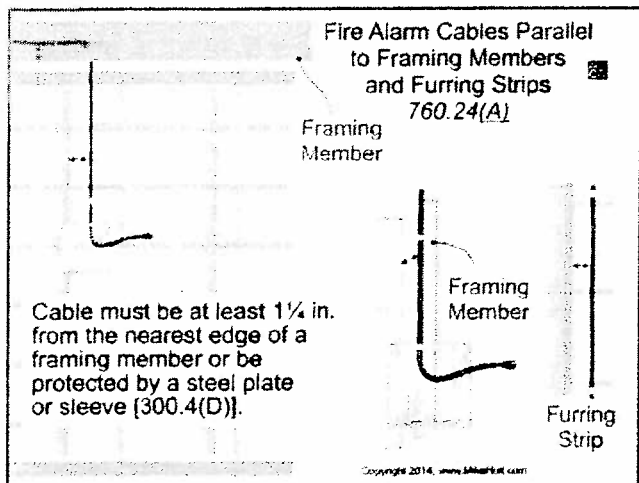

Figure 760-10

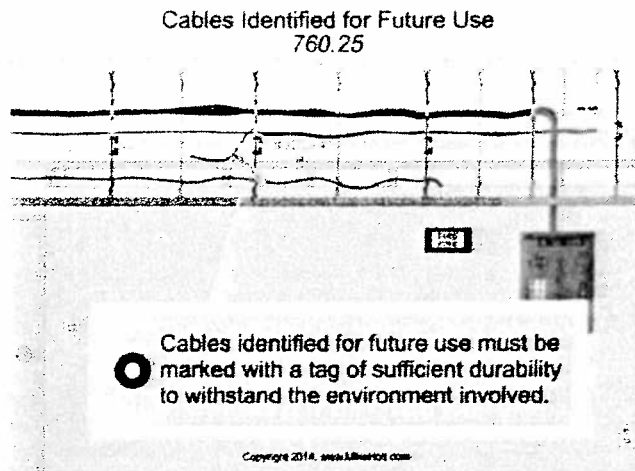

Figure 760-12

760.25 Abandoned Cable

To limit the spread of fire or products of combustion within a building, the accessible portion of cable that isn't terminated at equipment and not identified for future use with a tag must be removed [760.2].

Figure 760-11

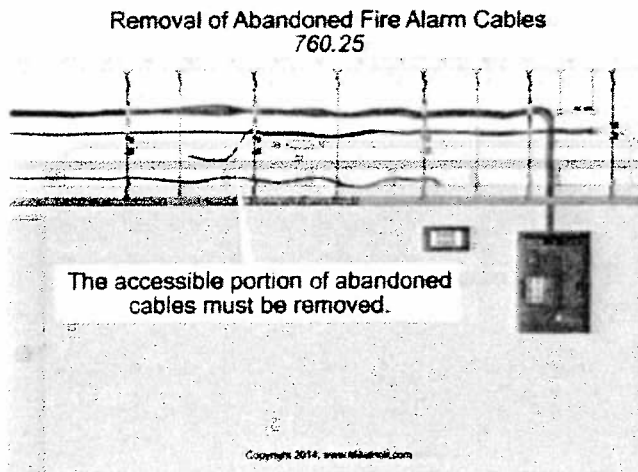

Figure 760-11

Cables identified for future use must be with a tag that can withstand the environment involved. Figure 760-12

Author's Comment:

- Cables installed in concealed raceways aren't considered "accessible"; therefore, they're not required to be removed.

760.30 Fire Alarm Circuit Identification

Fire alarm circuits must be identified at terminal and junction locations. The identification must be in such a manner that will help to prevent unintentional signals on the fire alarm system circuits during testing and servicing of other systems. Figure 760-13

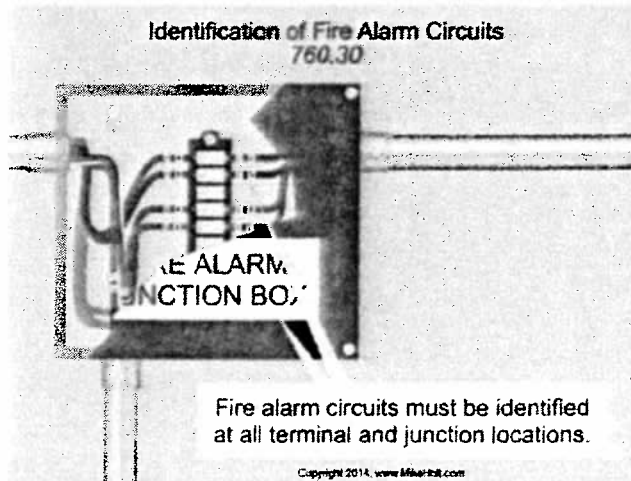

Figure 760-13

760.32 Fire Alarm Circuit Cables Extending Beyond a Building

If fire alarm circuit conductors extend beyond a building and run outdoors, they must be installed in accordance with Parts II, III, and IV of Article 800, and they must also be installed in accordance with Part I of Article 300.

760.35 Fire Alarm Circuit Requirements

(A) **Nonpower-Limited Fire Alarm Circuits.** Nonpower-limited fire alarm (NPLFA) circuits must comply with Parts I and II of this article.

(B) **Power-Limited Fire Alarm Circuits.** Power-limited fire alarm (PLFA) circuits must comply with Parts I and III of this article.

Part III. Power-Limited Fire Alarm (PLFA) Circuits

760.121 Power Sources for Power-Limited Fire Alarm Circuits

(B) **Branch Circuit.** Power-limited fire alarm equipment must be supplied by a branch circuit that supplies no other load and isn't GFCI or AFCI protected. Figure 760-14

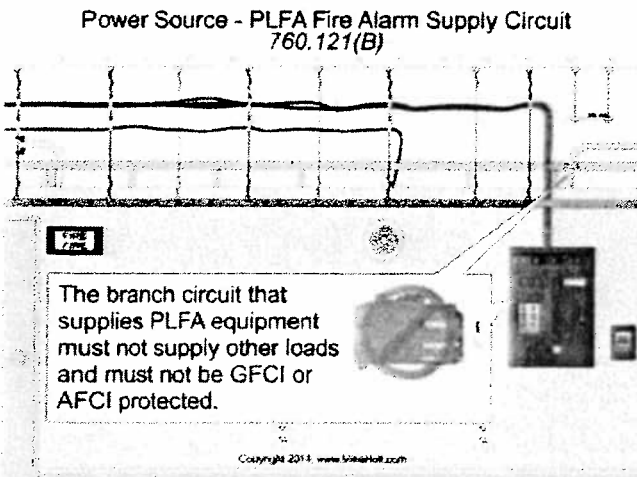

Figure 760-14

The location of the branch-circuit overcurrent device for the power-limited fire alarm equipment must be permanently identified at the fire alarm control unit. Figure 760-15

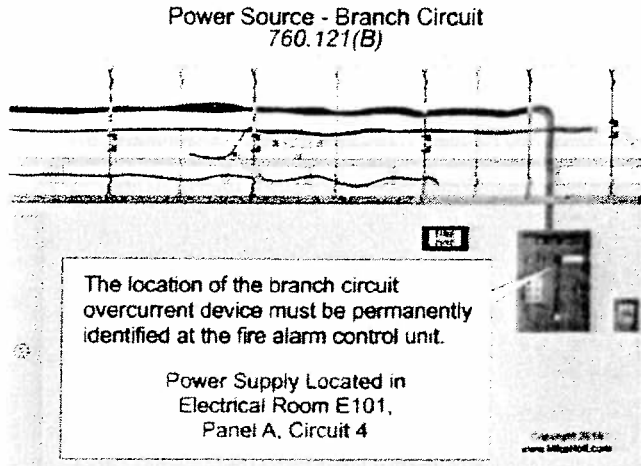

Figure 760-15

The branch-circuit overcurrent device must be identified in red, accessible only to qualified personnel, and identified as "FIRE ALARM CIRCUIT." The red identification must not damage the overcurrent protective device or obscure any manufacturer's markings. Figure 760-16

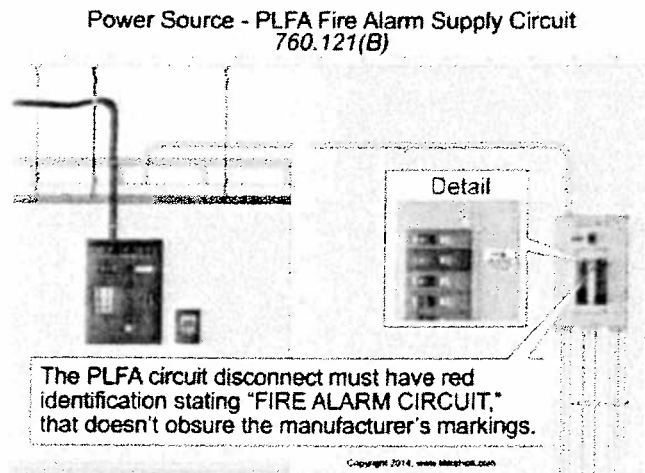

Figure 760-16

760.124 Equipment Marking

Fire alarm equipment supplying power-limited fire alarm cable circuits must be durably marked to indicate each circuit that's a power-limited fire alarm circuit.

Author's Comment:

- Fire alarm circuits must be marked at terminal and junction locations [760.30].

760.130 Wiring Methods on Load Side of Power-Limited Fire Alarm Power Source

(B) PLFA Wiring Methods and Materials. Power-limited fire alarm conductors and cables described in 760.179 must be installed as detailed in (1), (2), or (3) of this section and 300.7.

(1) Exposed or Fished in Concealed Spaces. Cable splices or terminations must be made in listed fittings, boxes, enclosures, fire alarm devices, or utilization equipment. Figure 760-17

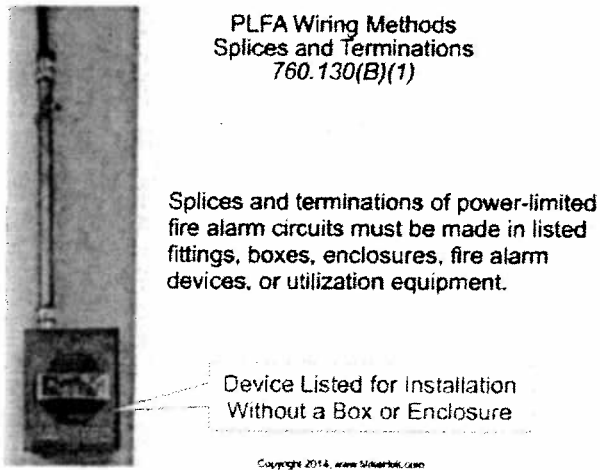

Figure 760-17

Power-limited fire alarm cable installed exposed must be adequately supported and protected against physical damage.

Author's Comment:

- Exposed cables must be supported by the structural components of the building so the cable won't be damaged by normal building use. Cables must be secured by straps, staples, hangers, or similar fittings designed and installed in a manner that won't damage the cable. Cables installed through or parallel to framing members or furring strips must be protected where they're likely to be penetrated by nails or screws, by installing the wiring method so it isn't less than 1/4 in. from the nearest edge of the framing member or furring strips, or it must be protected by a 1/16 in. thick steel plate or the equivalent [760.24(A)].

760.135 Installation of PLFA Cables in Buildings

Installation of power-limited fire alarm cables in buildings must comply with 760.135(A) through (J).

(A) Listing. PLFA cables installed in buildings must be listed.

(C) Plenum Spaces. Plenum rated FPLP cables are permitted in plenum spaces as described in 300.22(C). Figure 760-18

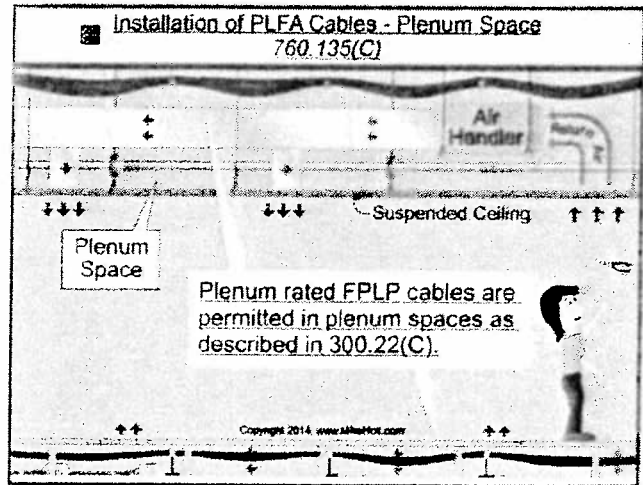

Figure 760-18

(H) Other Building Locations. The following cables are permitted to be installed in building locations other than the locations covered in 770.113(B) through (H):

- (1) Types FPLP, FPLR, and FPL cables
- (2) Types FPLP, FPLR, and FPL cables installed in:
 - a. Plenum communications raceways
 - b. Plenum cable routing assemblies
 - c. Riser communications raceways
 - d. Riser cable routing assemblies
 - e. General-purpose communications raceways
 - f. General-purpose cable routing assemblies
- (3) Types FPLP, FPLR, and FPL cables installed in a raceway of a type recognized in Chapter 3

760.136 Separation from Power Conductors

(A) General. Power-limited fire alarm conductors must not be placed in any enclosure, raceway, or cable with conductors of electric light, power, or Class 1 circuits.

(B) Separated by Barriers. If separated by a barrier, power-limited fire alarm circuits are permitted with electric power conductors.

Author's Comment:

- Separation is required to prevent a fire or shock hazard that can occur from a short between the fire alarm circuit and the higher-voltage circuits.

(D) Associated Systems Within Enclosures. Power-limited fire alarm conductors can be mixed with electric light, power, and Class 1 circuit conductors in enclosures where these other conductors are introduced solely for connection to the same equipment, and:

- (1) A minimum of ¼ in. separation is maintained from the power-limited fire alarm cable conductors.

(G) Other Applications. Power-limited fire alarm circuit conductors must be separated by not less than 2 in. from insulated conductors of electric light, power, or Class 1 circuits unless:

- (1) Electric light, power, Class 1 circuit conductors, or power-limited fire alarm circuit conductors, are in a raceway or in metal-sheathed, metal-clad, nonmetallic-sheathed, or underground feeder cables.

Figure 760-19

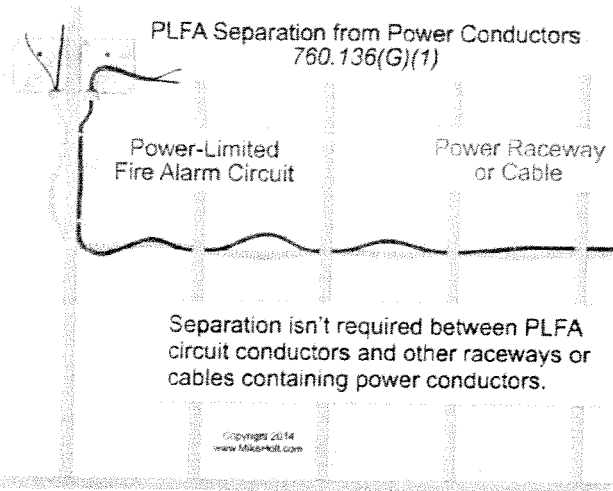

Figure 760-19

760.139 Power-Limited Fire Alarm Circuits, Class 2, Class 3, and Communications Circuits

(A) Two or More PLFA Circuits. Power-limited fire alarm circuits, communications circuits, or Class 3 circuits can be in the same cable, enclosure, cable tray, raceway, or cable routing assembly. Figure 760-20

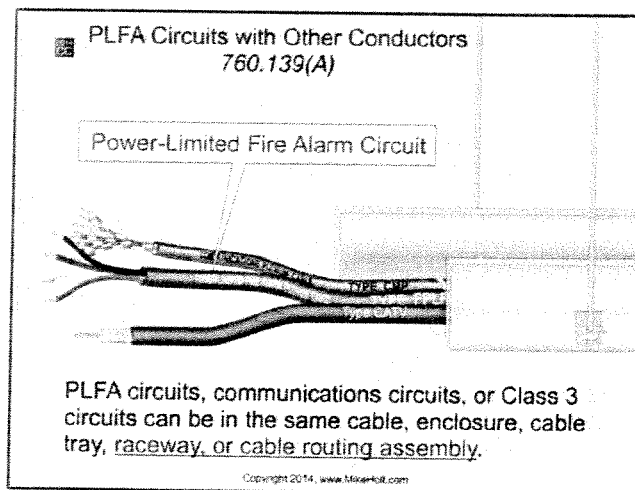

Figure 760-20

(B) PLFA and Class 2 Circuits. Class 2 circuits can be within the same cable, cable routing assembly, enclosure, cable tray, or raceway as conductors of power-limited fire alarm circuits provided the Class 2 circuit conductor insulation isn't less than that required for the power-limited fire alarm circuits.

Author's Comment:

- Listed Class 2 cables have an insulation voltage rating of at least 150V [725.179(G)], whereas listed power-limited fire alarm cables have a voltage rating of not less than 300V [760.179(C)].

(D) Audio System Circuits and Power-Limited Fire Alarm Circuits. Audio system circuits [640.9(C)] using Class 2 or Class 3 wiring methods [725.133 and 725.154] must not be installed in the same cable, cable routing assembly, cable tray, or raceway with power-limited fire alarm conductors or cables.

Author's Comment:

- The concern is that a fault from audio amplifier circuits to fire alarm circuits has the potential to create a hazard by disrupting the operation of fire alarm systems. However, this restriction doesn't apply to the voice annunciation audio circuits supplied and controlled from a fire alarm panel and commonly required in high-rise buildings and similar applications.

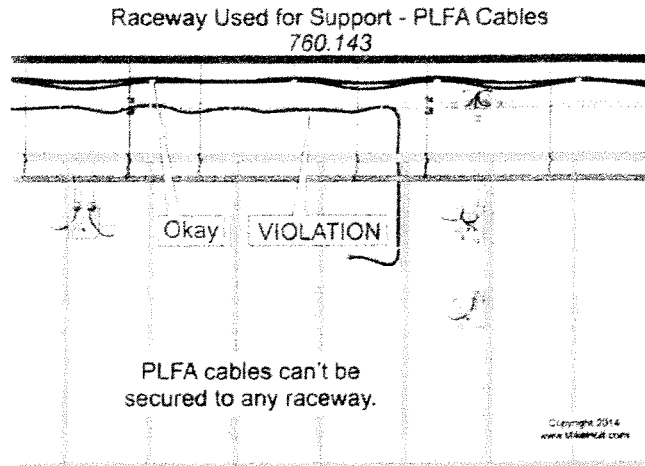

Figure 760-21

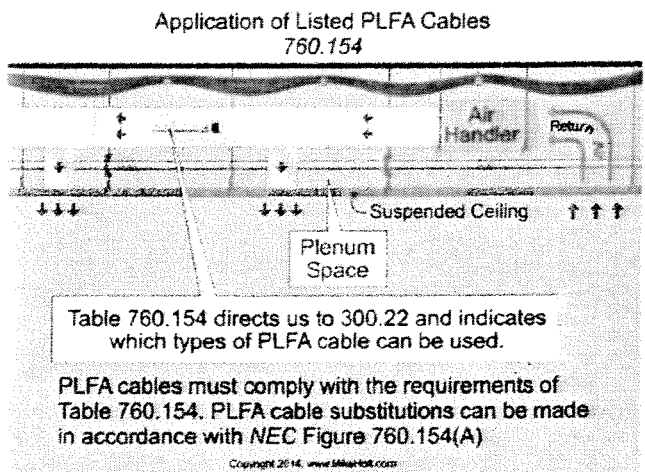

Figure 760-22

760.143 Support

Power-limited fire alarm cables aren't permitted to be strapped, taped, or attached to the exterior of any raceway as a means of support. Figure 760-21

760.154 Applications of Power-Limited Fire Alarm Cables (PLFA)

PLFA cables must meet the requirements of Table 760.154, or the substitutions allowed in 760.154(A). Figure 760-22

Part IV. Listing Requirements

760.179 Listing and Marking of Power-Limited Fire Alarm Cables (PLFA)

PLFA cable installed within buildings must be listed as being resistant to the spread of fire and other criteria in accordance with 760.179(A) through (H) and shall be marked in accordance with 760.179 (I).

(C) Ratings. Fire Alarm cable must have a voltage rating of not less than 300 volts. Figure 760-23

(D) Type FPLP. Type FPLP plenum cable is listed as being suitable for use in plenum space. Figure 760-24

(I) Marking. Cables must be marked in accordance with Table 760.179(I). Voltage ratings are not permitted to be marked on the cable.

Note: Voltage markings on cables may suggest that the cables are suitable for Class 1 or electric power and light applications, which they are not.

Listing and Marking of Type PLFA Cable - Rating 760.179(C)

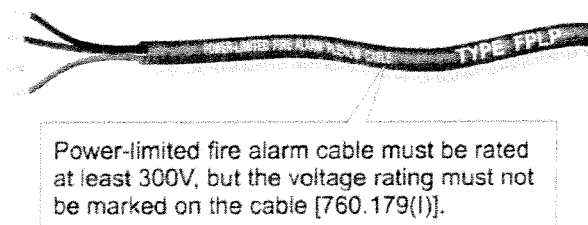

Copyright 2014, www.MikeHoit.com

Figure 760-23

Listing and Marking of PLFA Cable - Type FPLP 760.179(D)

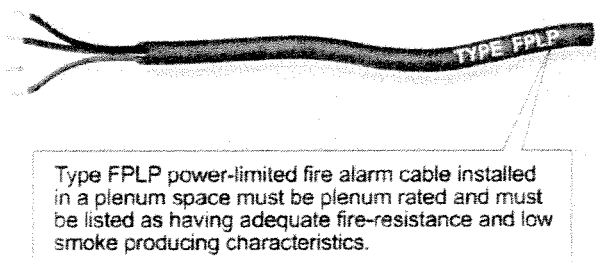

Copyright 2014, www.MikeHoit.com

Figure 760-24

20% OFF

Mike Holt's DETAILED CODE LIBRARY

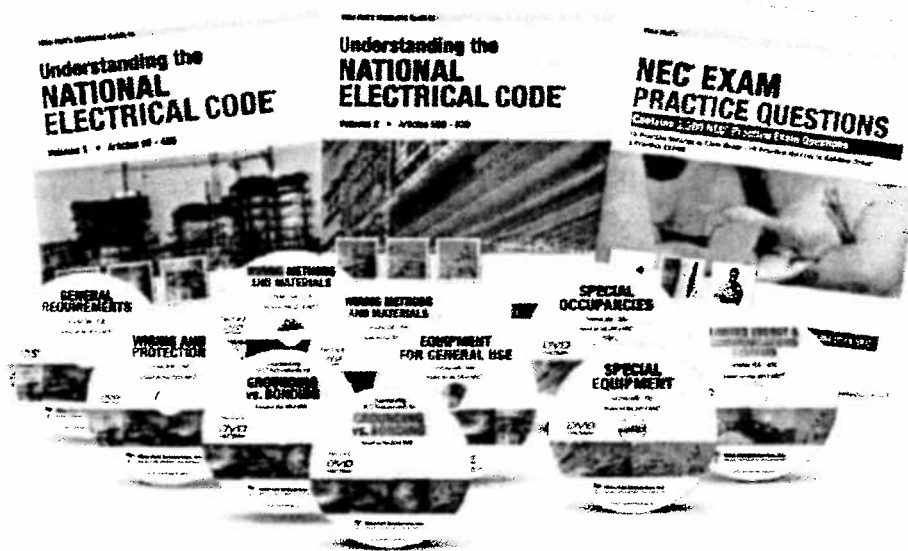

| PERFECT FOR ENGINEERS, ELECTRICIANS, CONTRACTORS AND ELECTRICAL INSPECTORS |

There isn't a better way to learn the Code than with Mike's Detailed Code Library. It takes you step-by-step through the NEC® in Code order, combining the unique writing style of Mike's textbooks, with his dynamic teaching style on the training DVDs. You get detailed instructional graphics, great practice questions, and in-depth analysis by Mike and a team of industry experts explaining the rules and their practical application.

Get your Copy for 20% off list price – use discount code UNDPDF14

"...as for me and my house, we will serve the Lord." (Joshua 24:15)

NAME _____ TITLE _____

COMPANY _____

ADDRESS _____

CITY _____ STATE _____ ZIP _____

PHONE _____

E-MAIL ADDRESS _____

VISA MASTERCARD DISCOVER AMEX MONEY ORDER CHECK

CREDIT CARD # _____ EXP. DATE _____

3 OR 4 DIGIT SECURITY CODE ON FRONT OF AMEX OR BACK FOR ALL OTHERS _____

2014 DETAILED CODE LIBRARY ORDER FORM

	PRICE	QTY	TOTAL
<input type="checkbox"/> DVD Program (includes 3 books & 10 DVDs)	List Price \$599 \$479.20	_____	\$ _____
			SUB-TOTAL \$ _____
			SALES TAX (FLORIDA RESIDENTS ONLY) ADD 6% \$ _____
			Shipping (5% of total price) - Minimum \$7.50 \$ _____
			TOTAL \$ _____

Mail form to: 3604 Parkway Blvd., Suite 3, Leesburg, Florida 34748
FOR VOLUME DISCOUNTS PLEASE CALL OUR OFFICE

Visit: www.MikeHolt.com/14DECO • Call: 888.NEC.CODE (632.2633) • Fax: 352.360.0983

Offer good through December 31, 2015



MIKE HOLT Enterprises, Inc.

APPLICATION FOR RULE CHANGE

Pursuant to section 3781.12 of the Revised Code and rules adopted by the Board of Building Standards, application is herewith submitted to adopt, amend, or annul a rule adopted by the Board pursuant to section 3718.10 of the Revised Code.



BOARD OF BUILDING STANDARDS

6606 Tussing Road, P.O. Box 4009
Reynoldsburg, Ohio 43068-9009
(614) 644-2613
bbs@ohio.gov
www.com.state.oh.us/dico/bbs/default.aspx

For BBS use:	
Petition #:	<u>16-09</u>
Date Recv'd:	<u>8/16/16</u>

Submitter: Pete Baldauf Southwest Division, Ohio Chapter, IAEL
(Contact Name) (Organization/Company)

Address: P.O. Box 205
(Include Room Number, Suite, etc.)

Maineville Ohio 45039
(City) (State) (Zip)

Telephone Number: (937) 415-2326 **Fax Number:** (937) 415-2319

Date: 8/11/2016 **E-mail Address:** petebaldauf@gmail.com

Code Section: 2011 OBC 1008.1.10

General Explanation of Proposed Change (attach additional sheets if necessary):
To remove conflicting verbiage to maintain uniformity between the OBC and NFPA 70

RECEIVED
AUG 16 2016
BOARD OF BUILDING STANDARDS

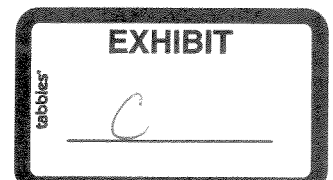

Formatted Rule Language

1008.1.10 Panic and fire exit hardware. Doors serving a group H occupancy and doors serving rooms or spaces with an occupant load of 50 or more in a Group A or E occupancy shall not be provided with a latch or lock unless it is panic hardware or fire exit hardware.

Exception: A main exit of a Group A occupancy in compliance with Section 1008.1.9.3, Item 2.

~~Electrical room doors shall comply with NFPA 70 as referenced in Chapter 35, s-with equipment rated 1,200 amperes or more and over 6 feet (1829 mm) wide that contains overcurrent devices, switching devices or control devices with exit or exit access doors shall be equipped with panic hardware or fire exit hardware. The doors shall swing in the direction of egress travel.~~

*Bailey's = Motion to accept concept and
 Table the motion for working out the details.
 = Seconded.*

APPLICATION

FOR
RULE CHANGE



BOARD OF BUILDING STANDARDS

6606 Tussing Road, P.O. Box 4009
 Reynoldsburg, Ohio 43068-9009
 (614) 644-2613
 bbs@ohio.gov
 www.com.state.oh.us/dico/bbs/default.aspx

Pursuant to section 3781.12 of the Revised Code and rules adopted by the Board of Building Standards, application is herewith submitted to adopt, amend, or annul a rule adopted by the Board pursuant to section 3718.10 of the Revised Code.

For BBS use:	
Petition #:	<u>16-10</u>
Date Recv'd:	<u>Sept 13, 2016</u>

Submitter: Philip Seyboldt, Ohio Building Officials' Association
(Contact Name) (Organization/Company)

Address: PO Box 1506
(Include Room Number, Suite, etc.)

Columbus OH 43216-1506
(City) (State) (Zip)

Telephone Number: 216-383-6312 Fax Number: _____

Date: September 13, 2016 building.commissioner@richmondheightsohio.org
 E-mail Address: _____

RECEIVED

SEP 13 2016

BOARD OF BUILDING STANDARDS

Code Section: OBC alter 104.6, 104.2.1.1, & 104.2.2.1.1. (See continuation sheet).

General Explanation of Proposed Change (attach additional sheets if necessary):

1. The Ohio Building Officials' Association (OBOA) is analyzing and developing solutions to staffing problems the departments are facing across Ohio. OBOA has summarized the following:

- a. Building Departments across Ohio and the Nation are facing staffing and budget shortfalls.
- b. Plans Examination is an important function of a building department, as approximately 52% of department staff is responsible for plan review.
- c. Building departments are required to have a Registered Architect or Professional Engineer on-staff or under contract, as a Master Plans Examiner.
- d. According to data collected by International Code Council (ICC) on professional registration requirements for plans examiners per state:
 - (1) Only 3 states require professional licensure (Ohio being one).
 - (2) Approximately 18 states only require ICC Certification for plans examination; and
 - (3) Ohio is one of a few states, which require both professional licensure and national certification in order to perform plans examination for commercial projects.

2. It is apparent that the professional licensure requirement limits the pool of individuals qualified to be certified as Master Plans Examiners (MPE).
(See continuation sheet.)



OHIO BUILDING OFFICIALS ASSOCIATION

PO BOX 1506, COLUMBUS OH 43216-1506
www.oboa.org



September 13, 2016

CHAPTER
MEMBERS

BOCONEO

COCOA

FBOA

MVBOC

NCOBOA

NWOBOA

ODPCA

SWOBOA

SWOFSC

Regina Hanshaw Esq, Executive Secretary
Ohio Board of Building Standards
PO Box 4009
Reynoldsburg OH 43068-9009

SUBJECT: Application/Petition for Rule Change, Personnel Certifications

Dear Regina;

The Ohio Building Officials' Association (OBOA) Board of Directors, on August 12, 2016, adopted a motion authorizing me to submit the subject application/petition. This proposal was developed through discussions with you and OBOA's Large and Medium Jurisdiction Committee including a meeting with OBOA representatives and BBS's Certification Committee. Feel free to contact our project officers Carl Lamping, ph 513-732-7213, e-mail clamping@clermontcountyohio.gov and Steve Risser PE, ph 419-755-9688, e-mail srisser@ci.mansfield.oh.us or myself at ph 216-383-6312, e-mail building.commissioner@richmondheightsohio.org if you've any questions.

Sincerely,

Philip Seyboldt
President
Ohio Building Officials Association

Atch
a/s

Information on Submittal (attach additional sheets if necessary):	
1. Sponsor:	Ohio Building Officials' Association (OBOA) <small>Organization sponsoring or requesting the rule change (if any)</small>
2. Rule Title:	OBC 104.1 Duties and Responsibilities. OAC 4101:7-1-02 Definitions. OAC 4101:7-2-01(B)(3) Elective Personnel. See continuation sheet. <small>Title of rule change</small>
3. Purpose/ Objective:	1. The following modifications of OAC Chapters 4101:1-1, 4101:7-1, 4101:7-2, and 4101:7-3 are proposed to allow individuals with construction industry experience who have demonstrated competency by passing the required examinations in their respective fields (building, electrical, plumbing, mechanical, fire protection), to be approved to review construction documents for certified departments. 2. OBOA proposes to add a new certification category called Elective Plans Examiners to OBC Section 104.2.2; which adds individual certifications for elective plans examiners and elective plans examiners trainees for all construction disciplines (building, electrical, plumbing, mechanical, fire protection). An experienced, non-registered individual could hold certification as an elective plans examiner for multiple disciplines provided the individual has met the experience and examination requirement for each discipline. 3. The Building Official is held responsible by BBS that the construction documents are properly examined (See continuation sheet.) <small>Technical justification for the proposed rule change</small>
4. Formatted Rule Language	104.1 General. Personnel of building departments and local boards of appeals that have been certified by the board of building standards, pursuant to <u>Chapter 4101:7-3 Building Department Personnel section 103</u> , shall be responsible for performing the duties described in this section. 104.2 building department personnel duties and responsibilities. Municipal, township, or county building departments certified by the board shall have personnel qualified to perform the enforcement duties and responsibilities described in this section. 104.2.1 Building Official. The building official is responsible for the enforcement of the rules of the board and of Chapters 3781 and 3791 of the Revised Code relating to the construction, arrangement, and the erection of buildings or parts thereof. All building officials shall conduct themselves in a professional, courteous, impartial, responsive, and cooperative manner. The building official shall render interpretations of this code and to adopt policies and procedures in order to clarify the application of its provisions. Such interpretations, policies, and procedures shall be in compliance with the intent and purpose of this code. Building officials shall be responsible to assure that a system is in place to track and audit all projects. (See continuation sheet) <small>Language formatted: strikethrough or underline per criteria above</small>
5. Notes:	1. To encourage uniformity among states using model codes, it is recommended that the submitter first submit any code change directly to ICC and participate in the national model code development process. 2. Please provide a copy of application and documentation. 3. Use a separate form for each code change proposal.

APPLICATION FOR RULE CHANGE

CONTINUATION SHEET

Submitter: Philip Seyboldt, Ohio Building Officials' Association (OBOA)

Code Section (Continued): Add OBC 104.2.2.2, 104.2.2.2.1, & 104.2.2.2.1.1. Renumber OBC 104.2.2.1.4 as 104.2.2.2.2 & alter. Add OBC 104.2.2.2.1. Renumber OBC 104.2.2.1.2 as 104.2.2.2.3 & alter. Add OBC 104.2.2.2.3.1. Renumber OBC 104.2.2.2.1.3 as 104.2.2.2.1.3 & alter. Add OBC 104.2.2.2.4.1, 104.2.2.2.5, & 104.2.2.2.5.1. OAC 4101:7-1-02 insert new (F), (L), & (R); relocate "Master plans examiner" before "Medical gas piping inspector," renumber existing (F) - (Y) as appropriate. OAC 4101:7-2-01(B)(3) add new (f) - (h). OAC 4101:7-3-01 add (41) - (49). OAC 4101:7-3-01(E) alter (2). OAC 4101:7-3-01(E)(2) replace (a) with (a)(i) and (b) with (a)(ii), renumber (a)(iii) as (c), and (a)(iv) as (d). OAC 4101:7-3-01(E) renumber (3) as (4) and alter, insert new (3). OAC 4101:7-3-01(E)(3) renumber (i) as (a), (ii) as (b), & (iii) as (c). Delete existing 4101:7-3-01(E)(3)(b). Renumber existing 4101:7-3-01(E)(3)(b)(i) - (iv) as 4101:7-3-01(E)(5)(a) - (d). Insert new 4101:7-3-01(E)(6), 4101:7-3-01(E)(6)(a) & (b). Renumber 4101:7-3-01(E)(4) as (7). Alter 4101:7-3-01(E) old (4)(a) new (7)(a) and old (4)(b) new (7)(b). Add 4101:7-3-01(E)(7)(c). Renumber 4101:7-3-01(E)(5) as (8). Alter 4101:7-3-01(E) old (5)(a) new (8)(a) and old (5)(b) new (8)(b). Renumber 4101:7-3-01(E)(6) as (9). Alter 4101:7-3-01(E) old (6)(a) new (9)(a) and old (6)(b) new (6)(a). Insert new 4101:7-3-01(E)(10) & 4101:7-3-01(E)(10)(a) - (c). Renumber 4101:7-3-01(E)(7) as (11), (8) as (12), (9) as (13), (10) as (14), (11) as (15), (12) as (16), & (13) as (17). OAC 4101:7-3-01(F)(a) renumber (iv) as (vi); insert new (iv), (iv)(a), (iv)(b), (iv)(b) a - c, & (v); alter old (iv)(a) new (vi)(a), old (iv)(b) new (vi)(b); renumber (v) as (vii) & (vi) as (viii). Alter OAC 4101:7-3-01(F)(b)(ii) & 4101:7-3-01(F)(d). OAC 4101:7-3-01(F)(e) renumber (ii)(a) as (iii) and alter, renumber (ii)(b) as (iv) & old (iii) as (v), and add (vi). Alter OAC 4101:7-3-01(6)(a)(i).

General Explanation of Proposed Change (Continued): 2. (Continued) OBOA believes there are currently inconsistencies in the way construction documents are required to be examined in certified building departments' verses the actual practices used to design buildings and prepare plans in typical building design firm.

3. In a typical building design firm, there is a licensed Architect or Engineer who will oversee the design and preparation of the plans and specifications. Unlicensed design professionals, technicians, draftspersons, or other individuals will prepare the plans and specifications, perform design work, submit drawings, correspond and coordinate various items, and perform other duties under the direction of the licensed and Registered Architect or Engineer. Effectively, one licensed individual can take responsibility of several unlicensed individuals.

4. The OBOA Board believes that the same principle, theory and practice should apply to the plans examination process in a BBS Certified Building Department. The OBOA Board proposes to add the option for Certified Building Departments to hire un-licensed individuals to supplement the review process. Currently, an MPE is required by OAC 4101:7-2-01 (B) (2) to be employed by or under contract with a Certified Building Department. And per OAC 4101:7-2-01(B) (3), a Certified Building Department may have elective plans examiners for Mechanical, Plumbing, and Electric plan reviews who report directly to the Building Official.

5. OBOA proposes to add Building and Fire Protection certifications as optional elective plan examiners, and add trainee positions for all disciplines of elective plan examiners. When elective plan examiners or

trainees are utilized, the department is currently and will continue to have a registered design professional involved in the plan examination process. OBOA understands that the registered design professional is an important resource for the Building Official to maintain a quality plan exam process.

6. OBOA believes by following the lead of the design professionals and opening up the applicant pool to those who are not licensed would greatly benefit certified building departments. OBOA is requesting approval from the BBS to allow all experienced individuals, **who have demonstrated competency by passing the required examinations in their respective fields**, to be certified to review construction plans and make recommendations to the Building Official.

Conclusion

7. Building Departments across Ohio and the Nation are facing staffing and budget shortfalls. An aging workforce has strained departments of experienced staff and created challenges to filling those positions with individuals who possess the experience and want to obtain the certifications to perform the required job duties.

8. Building departments which are certified in Ohio to enforce the Ohio Building Code (OBC) are required to have a Master Plans Examiner (MPE); either on-staff or under contract. An MPE is the only state certification that mandates licensure as a Registered Architect or Professional Engineer. Plans Examination is an important function of a building department. Approximately 52% of department staff is responsible for plan review in one form or another (International Code Council, *The Future of Code Officials*. August 2014 p9).

9. Currently, 4101:7-2-01 (B)(2) requires a Certified Building Department in the State of Ohio to have at least one MPE, and OAC rule 4101:7-3-01 (E)(3)(a)(i) requires an MPE to be an Ohio Registered Architect or Professional Engineer. This requirement is becoming burdensome as there are fewer applicants who are willing to commit the significant time and effort to become state certified as an MPE. In addition to the state architectural or engineering licensing board's requirements, an MPE candidate is also required to pass 4 exams (2-3 hours each in Building, Mechanical, Plumbing and Electrical codes) and attend 3 days of instruction at the Ohio Building Code Academy.

10. In a typical building design firm, there is a licensed Architect or Engineer who will oversee the design and preparation of the plans and specifications. Effectively, one licensed individual can take responsibility of several unlicensed individuals. The OBOA Board believes that the same principle, theory and practice can apply to the plans examination process in a BBS Certified building department. This proposal will add the option to hire elective plans examiners for regular plan reviews who report directly to the Building Official. For complex plan reviews, the requirement is to have a Registered Architect or Professional Engineer involved in the plan review process who report directly to the Building Official.

11. These proposed changes are intended to provide additional tools for Certified Building Departments to conduct the plan review process while maintaining the registered design professional's responsibility and interaction with such process within the Department. These proposed rule changes are not intended to remove the registered design professional from the plan review process.

12. In accordance with OBC 104.2.1, it is the responsibility of the Building Official to ensure that the registered design professional on staff or under contract is engaged in the plan examination process. The registered design professional may be the Building Official, the Master Plans Examiner, or one of the elective plans examiners; and, complex projects are required to be reviewed by a Master Plans Examiner as outlined in OBC 104.2.1.1. Requiring the Master Plans Examiner to perform the plan review for complex projects ensures design professional responsibility for projects that involve coordination of multiple scopes of work and technical analysis.

13. OBOA believes by following the lead of the design professionals and opening up the applicant pool to those who are not licensed would greatly benefit certified building departments. OBOA is requesting

approval from the BBS to have demonstrated competency by passing the required examinations in their respective fields, to be approved and certified to review construction plans and make recommendations of approval or denial to the Building Official.

3. Purpose/Objective (Continued): 3. (Continued) and in compliance with all of the rules of the board before issuing the plan approval. Currently, a Master Plans Examiner is required to review all types of construction documents, except when an electrical, plumbing or mechanical plan examiner is involved. All complex projects are reviewed by the Master Plans Examiner.

4. OBOA is proposing to modify Section 104.2.1 to require the Building Official to have at least one registered design professional involved in the plan examination process when a project is complex to maintain the existing quality of the plan review process conducted by the certified building departments.

4. Formatted Rule Language (Continued): OBC 104.2.1 (Continued) to assure that all building department personnel perform their duties in accordance with this section, and for the overall administration of a building department as follows:

104.2.1.1 Applications and plan approvals. The building official shall receive applications, require or cause the submitted construction documents to be examined, ascertain by such examinations whether the construction indicated and described is in accordance with the requirements of this code, and shall issue plan approvals for the construction, erection, alteration, demolition, and moving of buildings and structures. A Certified Building Department is required by 4101:7-2-01 (B)(2) to have a Master Plans Examiner to perform the plan examination and the Building Official who is responsible for the enforcement of the rules of the board and of Chapters 3781. and 3791. The Building Official shall have the option to require the Master Plans Examiner to review construction drawings; or, allow elective plans examiners to conduct plan examinations, to verify the construction indicated and described is in accordance with the requirements of this code. When the proposed scope of work involves technical design analysis and the construction documents are required to be sealed by a registered design professional per Section 106.2.1, the Building Official shall be required to have the Master Plans Examiner review the construction drawings, unless either the Building Official or one of the Elective Plans Examiners is a registered design professional.

104.2.1.1.1 Plan examination by the building official. When the building department does not have in its full-time employ a certified master plans examiner, the certified building official shall examine construction documents to determine compliance with the rules of the board if the registered design professional elects to submit construction documents that contain a written certification by the registered design professional indicating conformance with the requirements of the rules of the board and Chapters 3781. and 3791. of the Revised Code.

104.2.1.2 Orders.

No Changes Proposed to this Section

104.2.1.3 Inspections.

No Changes Proposed to this Section

104.2.1.4 Department records.

No Changes Proposed to this Section

104.2.1.5 Department reports.

No Changes Proposed to this Section

104.2.2 Plans examiners. A plans examiner is responsible for the examination of construction documents in accordance with section 107, within the limits of their certification, to determine compliance with the rules of the board. All plan examiners shall effectively communicate the results of their plan review as designated by the building official. A plans examiner shall conduct themselves in a professional, courteous, impartial, responsive, and cooperative manner.

104.2.2.1 Master plans examiner. A master plans examiner is responsible for the examination of all types of construction documents to determine compliance with the rules of the board, except when the building official examines the construction documents pursuant to section 104.2.1.1.1.

104.2.2.1.1 Master plans examiner trainee. A master plans examiner trainee is responsible for the examination of all types of construction documents to determine compliance with the rules of the board under the direct supervision of the approved trainee supervisor an individual holding a master plans examiner certification.

104.2.2.2 Elective plans examiners. Building departments may employ elective plan examiners to supplement the plan review process. The elective plan examiners may be designated by the building official as responsible for examination of construction documents for which they are certified to determine compliance with the rules of the board. To utilize elective plans examiners, the Department must have at least one design professional registered in Ohio as an architect or professional engineer as the Building Official, MPE, or one of the elective plan examiners. If the department does not have in its employ or under contract persons holding any of the elective plans examiners certifications, then the examination of the construction documents for compliance with the specific provisions of the code shall be done by the master plans examiner.

104.2.2.2.1 Building plans examiner. A building plans examiner is responsible for the examination of construction documents related to all general building construction and associated structural work to determine compliance with the rules of the board.

104.2.2.2.1.1 Building plans examiner trainee. A building plans examiner trainee is responsible for the examination of construction documents related to all general building construction and associated structural work to determine compliance with the rules of the board under the direct supervision of the approved trainee supervisor.

104.2.2.2.2.1.4 Mechanical plans examiner. A mechanical plans examiner is responsible for the examination of construction documents related to heating, ventilating, and air conditioning ("HVAC") systems and the associated refrigeration, fuel gas, and heating piping to determine compliance with the rules of the board.

~~If the department does not have in its employ or under contract persons holding the mechanical plans examiner certification, then the examination of the construction documents for compliance with the mechanical provisions of the code shall be done by the master plans examiner.~~

104.2.2.2.2.1 Mechanical plans examiner trainee. A mechanical plans examiner trainee is responsible for the examination of construction documents related to heating, ventilating, and air conditioning ("HVAC") systems and the associated refrigeration, fuel gas, and heating piping to determine compliance with the rules of the board under the direct supervision of the approved trainee supervisor.

104.2.2.2.3.1.2 Electrical plans examiner. An electrical plans examiner is responsible for the examination of construction documents related to electrical systems to determine compliance with the rules of the board.

~~If the department does not have in its employ or under contract persons holding the electrical plans examiner certification, then the examination of the construction documents for compliance with the electrical provisions of the code shall be done by the master plans examiner.~~

104.2.2.2.3.1.1 Electrical plans examiner trainee. An electrical plans examiner trainee is responsible for the examination of construction documents related to electrical systems to determine compliance with the rules of the board under the direct supervision of the approved trainee supervisor.

104.2.2.2.4.1.3 Plumbing plans examiner. A plumbing plans examiner is responsible for the examination of construction documents related to plumbing systems to determine compliance with the rules of the board.

~~If the department does not have in its employ or under contract persons holding the plumbing plans examiner certification, then the examination of the~~

construction documents for compliance with the plumbing provisions of the code shall be done by the master plans examiner.

104.2.2.2.4.1 Plumbing plans examiner trainee. A plumbing plans examiner trainee is responsible for the examination of construction documents related to plumbing systems to determine compliance with the rules of the board under the direct supervision of the approved trainee supervisor.

104.2.2.2.5 Fire Protection plans examiner. A fire protection plans examiner is responsible for the examination of construction documents related to fire protection systems (automatic sprinkler systems, alternative automatic fire-extinguishing systems, standpipe systems, fire alarm and detection systems, and fire pump) to determine compliance with the rules of the board.

104.2.2.2.5.1 Fire Protection plans examiner trainee. A fire protection plans examiner trainee is responsible for the examination of construction documents related to fire protection systems (automatic sprinkler systems, alternative automatic fire-extinguishing systems, standpipe systems, fire alarm and detection systems, and fire pump) to determine compliance with the rules of the board under the approved trainee supervisor.

104.2.3 Inspectors.

No Changes Proposed to this Section

104.2.4 Liability.

No Changes Proposed to this Section

104.3 Certified boards of building appeals duties and responsibilities.

No Changes to this

Section

104.4 Violation of duties.

No Changes Proposed to this Section

Chapter 4101:7-1 Generally

4101:7-1-02 Definitions. Unless otherwise stated, the following terms, as used in division 4101:7 of the Administrative Code, shall have the meanings shown herein.

(F) Building plans examiner. An individual who is certified in accordance with division (E) of section 3781.10 of the Revised Code and rule 4101:7-3-01 of the Administrative Code to perform the examination of construction documents related to all general building construction and associated structural work to determine compliance with the rules of the board.

(GF) Electrical plans examiner. An individual who is certified in accordance with division (E) of section 3781.10 of the Revised Code and rule 4101:7-3-01 of the Administrative Code to perform the examination of construction documents related to electrical systems to determine compliance with the rules of the board.

(HG) Electrical safety inspector. *No further changes proposed to old (G).*

(IH) Evidence. *No further changes proposed to old (H).*

(J) Fire alarm system. *No further changes proposed to old (I).*

(KJ) Fire alarm system designer. *No further changes proposed to old (J).*

(L) Fire Protection plans examiner. An individual who is certified in accordance with division (E) of section 3781.10 of the Revised Code and rule 4101:7-3-01 of the Administrative Code to perform the examination of construction documents related to fire protection systems (automatic sprinkler systems, alternative automatic fire-extinguishing systems, standpipe systems, fire alarm and detection systems, and fire pump) to determine compliance with the rules of the board.

(MK) Fire protection system inspector. *No further changes proposed to old (K).*

(NL) Fire protection system designer. *No further changes proposed to old (L).*

(OM) Interim certification. *No further changes proposed to old (M).*

(PO) Master plans examiner. An individual who is certified in accordance with division (E) of section 3781.10 of the Revised Code and rule 4101:7-3-01 of the Administrative Code to perform the examination of all types of construction documents to determine compliance with the rules of the board.

(QP) Mechanical inspector. *No further changes proposed to old (P).*

(R) Mechanical plans examiner. An individual who is certified in accordance with division (E) of section 3781.10 of the Revised Code and rule 4101:7-3-01 of the Administrative Code to perform the examination of construction documents related to heating, ventilating, and air conditioning ("HVAC") systems and the associated refrigeration, fuel gas, and heating piping to determine compliance with the rules of the board.

~~(SN) Medical gas piping inspector.~~ No further changes proposed to old (N).

~~(IQ) Plumbing inspector.~~ No further changes proposed to old (Q).

~~(UR) Plumbing plans examiner.~~ No further changes proposed to old (U).

~~(VS) Practice of electrical inspection.~~ No further changes proposed to old (S).

~~(WT) Rules of the board.~~ No further changes proposed to old (T).

~~(XH) Special hazards suppression system.~~ No further changes proposed to old (U).

~~(YV) Special hazards suppression system designer.~~ No further changes proposed to old (V).

~~(ZW) Trainee certification.~~ No further changes proposed to old (W).

~~(AAX) Water-based fire protection system.~~ No further changes proposed to old (X).

~~(BBY) Water-based fire protection system designer (formerly automatic sprinkler system designer.)~~
No further changes proposed to old (Y).

4101:7-2-01 Building department certification. Municipalities, townships, and counties may seek certification by the board of building standards as described in division (E) of section 3781.10 of the Revised Code to exercise enforcement authority, to accept and approve construction documents, and to make inspections.

(A) Certification types.

No Changes Proposed to Chapter (A)

(B) Building department certification requirements. To qualify for certification, a municipal, township, or county shall comply with the following:

(1) Conformity with law. The department shall submit an application and shall have been created in conformity with the law, shall have adopted ordinances or resolutions, and shall have entered into any agreements or contracts necessary to comply with the rules of the board and paragraph (C) of this rule;

(2) Required personnel. All personnel of municipal, township, or county building departments, and persons and employees of persons, firms, or corporations whose responsibilities include the exercise of enforcement authority shall be certified by the board of building standards pursuant to rule 4101:7-3-01 of the Administrative Code prior to performing such duties. A certified building department or sub-building department shall have the following personnel qualified to execute the duties required for the exercise of enforcement authority, the review and approval of construction documents, and the performance of inspections under the rules of the board:

(a) Building official.

(b) Masters plans examiner.

(c) Building Inspector.

(d) Plumbing inspector.

(e) Electrical safety inspector.

(f) Backup personnel. The department shall have in its employ or under contract alternate personnel meeting the requirements of rule 4101:7-3-01 of the Administrative Code, to serve in the event of a conflict of interest or the unavailability of the building official, plans examiner, or inspectors. All backup personnel shall be clearly identified and disclosed on the yearly operational report. For those backup personnel under contract, copies of the respective contracts shall also be submitted.

(g) Replacement personnel. When required personnel, both primary and back-up, leave the employ of the department, permanent replacement personnel shall be designated in accordance with the rules of the board within one hundred twenty days;

(3) Elective personnel. The department may elect to have the following personnel certified by the board of building standards pursuant to rule 4101:7-3-01 of the Administrative Code prior to performing such duties:

(a) Mechanical inspector.

(b) Fire protection inspector.

(c) Medical gas piping inspector.

(d) Electrical plans examiner.

(e) Plumbing plans examiner;

- (f) Building plans examiner;
- (g) Mechanical plans examiner;
- (f) Fire protection plans examiner.

(4) **Contract employees.** A municipal corporation, township, or county may contract with a certified building department, health district, or with persons, firms, or corporations under contract to furnish services, and meeting the requirements of rule 4101:7-3-01 of the Administrative Code, to exercise enforcement authority, administer the board's rules, approve plans and specifications and perform inspections on behalf of such municipal corporation, township, or county, providing such authority is exercised pursuant to such contract and upon application to and approval by the board of building standards. All contract employees shall be clearly identified and disclosed on the yearly operational report and copies of the respective contracts shall also be submitted;

(5) **Building department office.** The certified building department shall have an office conveniently located within the area it serves. The office shall be open and staffed to serve the public need and office hours shall be conspicuously posted. If the department contracts for its enforcement services, or is certified as a sub-building department, information shall be provided to the public explaining how building department services shall be provided;

(6) **Availability of inspectors.** The building department shall be staffed so that all inspectors are available, during normal business hours, for requested inspections as required in section 108.1 of rule 4101:1-1-01 of the Administrative Code. The department may offer inspections at other times at the request of the owner or owner's representative; and

(7) **Building department certificate to be posted.** The certificate issued by the board of building standards to a municipal, township, or county building department shall be posted in a conspicuous place within the jurisdiction.

(C) **Building department certification application.** *No Changes Proposed to Chapter (C)*

(D) **Building department certification, certification hearing.** *No Changes Proposed to Chapter (D)*

(E) **Building department certification, board to maintain list.** *No Changes Proposed to Chapter (E)*

(F) **Building department certification, reports, and assessment.** *No Changes Proposed to Chapter (F)*

(G) **Building department certification, revocation or suspension.** *No Changes Proposed to Chapter (G)*

(H) **Special building department requirements.** *No Changes Proposed to Chapter (H)*

Chapter 4101:7-3 Building Department Personnel

4101:7-3-01 Residential and non-residential building department personnel certification.

Residential and non-residential building departments shall have personnel qualified to execute the duties required to enforce the rules of the board. Only those certified individuals employed by or under contract with a particular political subdivision are authorized to exercise enforcement authority within that same jurisdiction. Exception: Inspectors performing industrialized unit inspections on behalf of the board of building standards.

(A) **Building department personnel certification classifications.** The certifications issued by the board of building standards are as follows:

- | | |
|--|--|
| (1) Building official. | (15) Mechanical plans examiner. |
| (2) Interim building official. | (16) Interim mechanical plans examiner. |
| (3) Residential building official. | (17) Building inspector. |
| (4) Interim residential building official. | (18) Interim building inspector. |
| (5) Master plans examiner. | (19) Building inspector trainee. |
| (6) Interim master plans examiner. | (20) Residential building inspector. |
| (7) Master plans examiner trainee. | (21) Interim residential building inspector. |
| (8) Residential plans examiner. | (22) Residential building inspector trainee. |
| (9) Interim residential plans examiner. | (23) Fire protection inspector. |
| (10) Residential plans examiner trainee. | (24) Interim fire protection inspector. |
| (11) Electrical plans examiner. | (25) Mechanical inspector. |
| (12) Interim electrical plans examiner. | (26) Interim mechanical inspector. |
| (13) Plumbing plans examiner. | (27) Mechanical inspector trainee. |
| (14) Interim plumbing plans examiner. | (28) Residential mechanical inspector. |

- (29) Interim residential mechanical inspector.
- (30) Residential mechanical inspector trainee.
- (31) Electrical safety inspector.
- (32) Electrical safety inspector trainee.
- (33) Non-residential industrialized unit inspector.
- (34) Interim non-residential industrialized unit inspector.
- (35) Residential industrialized unit inspector.
- (36) Interim residential industrialized unit inspector.
- (37) Plumbing inspector.
- (38) Interim plumbing inspector.
- (39) Plumbing inspector trainee.
- (40) Medical gas piping inspector.
- (41) Electrical Plans Examiner trainee
- (42) Plumbing Plans Examiner trainee
- (43) Mechanical Plans Examiner trainee
- (44) Building Plans Examiner
- (45) Interim Building Plans Examiner
- (46) Building Plans Examiner trainee
- (47) Fire Protection Plans Examiner
- (48) Interim Fire Protection Plans Examiner
- (49) Fire Protection Plans Examiner trainee

(B) **Multiple personnel certifications held.** A person may hold more than one certification.

(C) **Conflict of interest.** No certified employee or person who contracts for services within the jurisdictional area of a residential or non-residential building department shall perform services for any department which would require that person or employee to exercise authority or make an evaluation of any work furnished by him or by a private contractor that employs him on a full-time, part-time, or incidental basis. Further, such employee or person shall not engage in conduct that is prohibited or considered a conflict of interest pursuant to Chapter 102. of the Revised Code.

(D) **Seals.** No holder of a certification issued by the board of building standards is authorized to secure a seal in any form or of any type for use in the performance of any of their duties.

(E) **Experience requirements of the applicant to qualify for examination.**

(1) **General experience.** To qualify for certification examination, applicants must have experience directly related to buildings or structures within the scope of the "Residential Code of Ohio" for residential certifications or experience directly related to buildings or structures within the scope of the "Ohio Building Code" for non-residential certifications.

(a) In evaluating experience of an applicant, the board of building standards may find the following enforcement, inspection, or plans examination experience to be acceptable:

(i) Prior to 1984, for a non-residential building department certified by the board of building standards to exercise enforcement authority for buildings or structures within the scope of groups regulated by the rules of the board; or

(ii) For an agency or jurisdiction outside the state of Ohio enforcing a model residential code, for residential certifications, or a model non-residential building code, for non-residential certifications, of a national model code organization or a code adopted for the respective buildings or structures of the types regulated by the rules of the board; or

(iii) Certification by the department of commerce, division of industrial compliance, as a plumbing inspector when application is made for board certification as a plumbing inspector; or

(iv) Certification by the board as a non-residential building official, master plans examiner, or building inspector for residential certification as a residential building official, residential plans examiner, or residential building inspector.

(b) In evaluating experience of an applicant, the board of building standards may find acceptable experience as an employee of a certified residential or non-residential building department who is a holder of a board certification other than that for which application is being made as prescribed in this rule. Exceptions:

(i) Certified building department employees who are applicants for plumbing inspector certification shall comply with paragraph (E)(10) of this rule.

(ii) Certified building department employees who are applicants for electrical safety inspector certification shall comply with paragraph (E)(11) of this rule.

(c) In evaluating experience of an applicant, the board of building standards shall not credit experience gained while acting in violation of rules adopted by the board to establish equivalent experience. The board of building standards may credit experience which provides knowledge of different construction methods, processes, or types as it determines applicable, but shall not credit construction experience that does not provide required knowledge including, but not limited to, the installation of floor and wall coverings, the installation of roofing materials or roofing systems, or the finishing of concrete.

(d) In evaluating experience of an applicant, for a residential or non-residential certification, the board of building standards shall credit one year of the required experience obtained through education credit pursuant to paragraph (F)(6) of this rule.

(2) **Building official.** An applicant for a building official certification for a non-residential building department shall meet one of the following requirements:

~~(a) Non-residential building department:~~

~~(a)(i)~~ At least five years of experience in non-residential building design and construction for buildings or structures within the scope of groups regulated by the rules of the board while registered in Ohio as an architect or professional engineer;

~~(b)(ii)~~ At least ten years of experience as a general contractor or superintendent of building construction for buildings or structures dealing with all phases and trades of construction including the responsibility for obtaining approvals and inspections within the scope of groups regulated by the rules of the board;

~~(c)(iii)~~ At least five years of experience employed full-time as a residential building official in a certified residential building department; or

~~(d)(iv)~~ In evaluating the experience requirements for this certification, the board may accept applicable experience as specified in paragraph (E)(1) of this rule.

~~(b) Residential building department:~~

(3) **Residential building official.** An applicant for a residential building official certification for a residential building department shall meet one of the following requirements:

(a)(i) Ohio registration as an architect or professional engineer;

(b)(ii) At least five years of experience as a residential contractor or non-residential contractor or superintendent with responsibility for obtaining approvals and inspections of structures regulated by the rules of the board; or
(c)(iii) In evaluating the experience requirements for this certification, the board may accept applicable experience as specified in paragraph (E)(1) of this rule.

~~(4)(3)~~ **Master plans examiner.** An applicant for a non-residential master plans examiner ~~or residential plans examiner~~ certification shall meet the following respective requirements:

~~(a) Non-residential building department:~~

~~(a)(i) At least five years of experience in building design and construction for buildings or structures within the scope of groups regulated by the rules of the board while registered in Ohio as an architect or professional engineer;~~

~~(b)(ii) In evaluating the experience requirements for this certification, the board may accept applicable experience as specified in paragraph (E)(1) of this rule; or~~

~~(c)(iii) Successful completion of a trainee program pursuant to paragraph (F)(5) of this rule.~~

~~(5)(3)~~ **Residential plans examiner.** An applicant for a residential plans examiner certification shall meet one of the following respective requirements;

~~(b) Residential building department:~~

~~(a)(i) Ohio registration as an architect or professional engineer;~~

~~(b)(ii) At least five years of experience in building design and construction for residential or non-residential buildings or structures regulated by the rules of the board;~~

~~(c)(iii) In evaluating the experience requirements for this certification, the board may accept applicable experience as specified in paragraph (E)(1) of this rule; or~~

~~(d)(iv) Successful completion of a trainee program pursuant to paragraph (F)(5) of this rule.~~

~~(6)~~ **Building plans examiner.** An applicant for a building plan examiner certification shall meet the following requirements:

~~(a) At least five years of experience as a full-time building inspector in a certified non-residential building department; or~~

~~(b) At least five years of experience in building design and construction for buildings or structures within the scope of groups regulated by the rules of the board while a registered architect or professional engineer.~~

~~(7)(4)~~ **Electrical plans examiner.** An applicant for an electrical plans examiner certification shall meet the following requirements:

~~(a) At least five years of experience as a full-time electrical safety inspector in a certified non-residential building department; or~~

~~(b) At least five years of experience as an electrical safety inspector, certified pursuant to Chapter 3783. of the Revised Code and employed full-time by the Ohio department of commerce, division of industrial compliance; or~~

~~(c) At least five years of experience in building design and construction for buildings or structures within the scope of groups regulated by the rules of the board while a registered architect or professional engineer.~~

~~(8)(5)~~ **Plumbing plans examiner.** An applicant for a plumbing plans examiner certification shall meet one of the following requirements:

~~(a) At least five years' experience as a full-time plumbing inspector in a certified non-residential building department; or~~

~~(b) At least five years' experience as a plumbing inspector, certified pursuant to Chapter 3703. of the Revised Code, employed full-time by either the Ohio department of commerce, division of industrial compliance, or by a county board of health; or~~

~~(c) At least five years of experience in building design and construction for buildings or structures within the scope of groups regulated by the rules of the board while a registered architect or professional engineer.~~

~~(9)(6)~~ **Mechanical plans examiner.** An applicant for a mechanical plans examiner certification shall meet one of the following requirements:

~~(a) At least five years of experience as a full-time mechanical inspector in a certified non-residential building department; or~~

~~(b) At least five years of experience as a full-time residential building official, residential plans examiner, residential building inspector, or residential mechanical inspector in a certified residential building department; or~~

~~(c) At least five years of experience in building design and construction for buildings or structures within the scope of groups regulated by the rules of the board while a registered architect or professional engineer.~~

~~(10)~~ **Fire protection plans examiner.** An applicant for a fire protection plan examiner certification shall meet the following requirements:

~~(a) At least five years of experience as a full-time fire safety inspector in a fire department or non-residential building department with experience inspecting non-residential fire protection systems.~~

~~(b) At least five years of experience as a full-time building inspector in a certified non-residential building department; or~~

~~(c) At least five years of experience in building design and construction for buildings or structures within the scope of groups regulated by the rules of the board while a registered architect or professional engineer.~~

- | | |
|---|--|
| (11) (7) Building inspector. | <i>No Changes Proposed to this Section</i> |
| (12) (8) Fire protection inspector. | <i>No Changes Proposed to this Section</i> |
| (13) (9) Mechanical inspector. | <i>No Changes Proposed to this Section</i> |
| (14) (10) Plumbing Inspector. | <i>No Changes Proposed to this Section</i> |
| (15) (11) Electrical safety inspector. | <i>No Changes Proposed to this Section</i> |
| (16) (12) Industrialized unit inspector. | <i>No Changes Proposed to this Section</i> |
| (17) (13) Medical Gas piping inspector. | <i>No Changes Proposed to this Section</i> |

(F) **Personnel certification application, filing and processing.** Applications for certification shall be sent to the office of the board at least two weeks prior to a certification hearing. The application shall expire if not approved within one year of receipt by the board. Applications for certification as an electrical safety inspector shall be submitted at least two weeks prior to a meeting of the electrical safety inspector advisory committee.

Each applicant shall also submit, with the application, payment of an initial fee of thirty dollars and evidence sufficient to show the board that the applicant is qualified. Such evidence may include proof of the statements made in the application, documentary evidence, affidavits, transcripts, diplomas, published data, photographs, or legible reproductions of the same, or any other documentation.

- | | |
|---|--|
| (1) Certification process. | <i>No Changes Proposed to this Section</i> |
| (2) Issuance of certificate and renewal. | <i>No Changes Proposed to this Section</i> |
| (3) Continuing education. | <i>No Changes Proposed to this Section</i> |
| (4) Elective temporary suspension. | <i>No Changes Proposed to this Section</i> |

(5) **Trainee program requirements.** Individuals seeking certification as a trainee shall meet the requirements of this section.

(a) **Trainee applicants.** Trainees shall meet the following requirements:

- (i) A trainee applicant shall be a full time employee of a political subdivision.
- (ii) A trainee applicant shall be under the direct supervision of a trainee supervisor.
- (iii) A master plan examiner trainee applicant shall also be a graduate of an NAAB, EAC-ABET, or similarly accredited architecture or engineering university program.
- (iv) A building, mechanical, electrical, plumbing, or fire protection plan examiner trainee of a non-residential building department shall:

- (a) Be a graduate of an NAAB, EAC-ABET, or similarly accredited architecture or engineering university program; or
- (b) Have at least three years of experience as outlined below or shall submit evidence of eligibility for education credit pursuant to section paragraph (F)(6) of this rule.
 - a. As a full-time building inspector, fire protection inspector, plumbing inspector, electrical safety inspector, or mechanical inspector in a certified non-residential building department, of the division of industrial compliance in the Ohio department of commerce, or of county boards of health; or
 - b. As a full-time residential building official, residential plans examiner, residential building inspector, or residential mechanical inspector in a certified residential building department; or
 - c. As a full time designer working under the direct supervision of a Design Professional preparing Construction Documents of any discipline directly related to buildings or structures within the scope of groups regulated by the Ohio Building Codes.

(v) Residential plan examiner trainee applicant for a residential building department shall have at least three year of experience as a full time designer working under the direct supervision of a Design Professional preparing Construction Documents ; or, a skilled tradesman for work subject to inspection under a residential or non-residential code adopted for buildings or structures regulated by the "Residential Code of Ohio", or shall submit evidence of eligibility for education credit pursuant to paragraph (F) (6) of this rule.

~~(vi)~~(iv) Building inspector or mechanical inspector trainee applicant:

- (a) A building inspector or mechanical inspector trainee applicant for a non-residential building department shall ~~also~~ have at least ~~three one~~ years of experience as a skilled tradesman for work subject to inspection under either a model building code of a national model code organization or a code adopted for buildings or structures and within the scope of groups regulated by the rules of the board or shall submit evidence of eligibility for education credit pursuant to section paragraph (F)(6) of this rule.
- (b) The building inspector or mechanical inspector trainee applicant for a residential building department shall ~~also~~ have at least ~~three one~~ year of experience as a skilled tradesman for work subject to inspection under a residential or non-residential code adopted for buildings or structures regulated by the

"Residential Code of Ohio" or the "Ohio Building Code," or shall submit evidence of eligibility for education credit pursuant to paragraph (F) (6) of this rule.

(vii) A plumbing inspector trainee applicant shall have at least three years of experience in the installation of plumbing subject to inspection under either a model building code of a national model code organization or a code adopted for buildings or structures and within the scope of groups regulated by the rules of the board, or comply with the provisions of paragraph (E) (1) of this rule. Applicants may submit evidence of eligibility for education credit pursuant to paragraph (F) (6) of this rule.

(viii) An electrical safety inspector trainee applicant shall have two years of experience in the installation of electrical systems subject to inspection under either a model building code of a national model code organization or a code adopted for buildings or structures and within the scope of groups regulated by the rules of the board or shall submit evidence of eligibility for education credit pursuant to paragraph (F) (6) of this rule.

(b) Trainee supervisors. A trainee supervisor shall:

(i) Be a full time employee of the same political subdivision as the trainee and shall be available to the trainee during normal working hours;

(ii) Currently possess the certification for which the trainee is being trained, or possess the master plan examiner certification to supervise an elective plans examiner;

(iii) Be responsible for no more than two trainees at one time and shall immediately notify the board of the trainee(s) under supervision;

(iv) Notify the board of any change in supervisor or trainee status within thirty days;

(v) Supervise, check, and sign the trainee's inspections and reports or a plans examiner trainee's plans examinations; and

(vi) Provide to the board a report documenting at least twenty-five inspections or plans examinations made yearly by the trainee under the direct supervision of the trainee supervisor, with an evaluation of the trainee at the end of the first six months of the program, at the end of one year, and annually afterward.

Exception: The trainee supervisor of a trainee engaged in making electrical inspections shall supervise and check the trainee's work and be responsible for and sign off on all of the trainee's inspections, reports, and interpretations.

(c) Trainee sponsor requirements. The trainee sponsor (county, township, or municipal corporation) shall:

(i) Direct the appropriate building official to certify to the board that the trainee is a full time employee of the county, township, or municipal corporation and is under the direct supervision of an individual possessing the certification for which the trainee is being trained; and

(ii) Provide the trainee with a copy of the current rules of the board.

(d) Trainee certification. The board shall issue a trainee certification to each applicant who has met the qualification requirements. The certification shall expire ~~four~~ six years from the date of applicant approval by the board. After a minimum of two years, or four years for electrical safety inspector trainees, and upon satisfactory completion of the trainee program pursuant to paragraph (F)(5)(e) of this rule, the trainee may apply for certification in the respective classification. The trainee certification is not renewable and upon expiration the individual may not reapply as a new trainee for a period of one year.

(e) Trainee course and work requirements.

(i) Building, mechanical, or plumbing inspector trainee:

(a) The non-residential trainee shall attend and successfully complete two hundred hours of approved building code education courses. During the first year the trainee shall complete at least one hundred hours of course work, including completion of the "Ohio Building Code Academy" as required in paragraph (F)(3) of this rule, and complete the second one hundred hours prior to completion of the trainee program. The trainee shall perform at least twenty-five inspections annually while in the trainee program under the direct supervision of the trainee supervisor.

(b) The residential trainee shall attend and successfully complete one hundred hours of approved building code education courses. The trainee shall perform at least twenty-five inspections annually while in the trainee program under the direct supervision of the trainee supervisor and shall complete the "Ohio Building Code Academy" as required in paragraph (F)(3) of this rule.

(ii) Master plans examiner trainee:

~~(iii)(a)~~ A ~~non-residential~~ master plans examiner trainee shall perform at least twenty-five plans examinations yearly under the direct supervision of the trainee supervisor, complete at least ten hours of approved continuing building code education courses yearly, and become registered in Ohio as an architect or professional engineer prior to the completion of the trainee program.

~~(iv)(b)~~ The residential plans examiner trainee shall perform at least twenty-five plans examinations yearly under the direct supervision of the trainee supervisor and complete at least one hundred hours of approved continuing

building code education courses. The trainee shall also complete the appropriate examination requirements prior to the completion of the trainee program.

(v)(iii) An electrical safety inspector trainee: The trainee shall attend and successfully complete two approved thirty-hour courses and related tests covering the fundamentals of electricity and the "National Electrical Code." During the first year, the trainee shall attend one of the two courses and pass the related test. The second course and test shall be successfully completed prior to the examination for a certification.

(vi) An elective plan examiner trainee shall attend and successfully complete two hundred hours of approved code education courses. During the first year the trainee shall complete at least one hundred hours of course work, including completion of the "Ohio Building Code Academy" as required in paragraph (F)(3) of this rule, and complete the second one hundred hours prior to completion of the trainee program. The trainee shall perform at least twenty-five plans examinations annually while in the trainee program under the direct supervision of the approved trainee supervisor.

(6) **Education credit.** An applicant for a board certification may obtain credit for one year of the required experience through education pursuant to the following:

(a) **Documentation.** Supporting documentation shall be provided and may include a certificate of completion, a career passport, a transcript, a college degree or diploma granted by an accredited or state sponsored institution.

(i) The applicant shall document nine hundred or more contact hours of training in an ~~Ohio department of education~~ approved vocational education program at the high school or adult level; or

(ii) The applicant shall document the completion of a baccalaureate degree or an associate degree program in building design or construction.

(b) **Educational programs.** Education credit shall not be prorated or combined for partial or full credit and shall be awarded only upon successful completion of a specific educational program. Miscellaneous course work or isolated classes shall not be considered.

(i) Vocational programs. Vocational instructional programs that are acceptable for credit include

(a) Air conditioning, heating, and ventilation.

(b) Carpentry.

(c) Electricity.

(d) Masonry.

(e) Plumbing and pipefitting.

(f) Firefighting.

(ii) Technical programs. Technical education instructional programs offering associate degrees that are acceptable for credit include:

(a) Architectural/construction technology.

(b) Heating and air conditioning technology.

(c) Fire science technology.

(iii) Other programs. The successful completion of other specific vocational instructional programs of a minimum of nine hundred contact hours or technical education instructional programs may be considered by the board if the training is directly related to the design and construction of buildings or structures within the scope of groups regulated by the rules of the board.

An applicant for electrical safety inspector trainee may obtain credit for one year of required experience through the completion of approved vocational training in the fundamentals of electricity.

(7) **Certification, revocation or suspension.**

No Changes Proposed to this Section

October 25, 2016
Ohio Board of Building Standards
Regina Hanshaw, Executive Secretary
6606 Tussing Road
Reynoldsburg, Ohio 43068

Re: Petition to update referenced standard NFPA 70 National Electrical Code 2014 edition to the 2017 edition

Rule Titles:

4101:1-35-01 Referenced standards: ~~70-14 National Electrical Code~~ 70-17 National Electrical Code

4101:2-15-01 Referenced standards: ~~70-14 National Electrical Code~~ 70-17 National Electrical Code

4101:3-13-01 Referenced standards: ~~70-14 National Electrical Code~~ 70-17 National Electrical Code

Submitter:

Sponsor: Ohio Electrical Coalition

Reason and Technical Justification for Rule Change:

Pursuant to O.R.C. 3781.12, the Ohio Electrical Coalition respectfully requests the Ohio Board of Building Standards update the 2014 edition of NFPA 70 with the 2017 edition of NFPA 70.

The NFPA 70 community has worked diligently to make sure safe installation rules are in place for the continuously changing electrical industry landscape. The 2017 edition of NFPA 70 was issued by the NFPA Standards Council on August 4, 2016 and was approved as an American National Standard on August 24, 2016.

New requirements for utility-scale PV systems, direct-current microgrids and energy storage systems are examples of the regulatory piece trying to keep up with the innovation piece. These are exciting times for the electrical industry as we transition from centralized utility supplied electricity to on-site generation, distribution and storage. Timely adoption of the 2017 NFPA 70 will ensure we don't hamstring innovators, installers and most importantly the regulators with respect to advancements in technology and innovation. Advancement of technology requires up-to-date standards for safe implementation to ensure that the end-user can take advantage of this innovation without endangering themselves or their property. Up-to-date safety standards promote the use of new technology, which has immeasurable societal benefits at both a micro- and macro-economic perspective.

The 2017 NFPA 70 also advances new methods and installation practices for safely distributing electrical power, safe interaction with electrical systems, to address safety concerns not previously covered in the referenced standard and furthers the fire and shock prevention mission of the code. Updating to the 2017 NFPA 70 is a vitally important and proactive step for consumer protection and for the safe advancement of new electrical system technology.

Following are some of the major key changes that impact electrical safety:

Keeping the regulatory document current with industry trends in new technology and delivery and generation of electric power.

- Article 425 Fixed Resistance and Electrode Industrial Process Heating Equipment - new article addresses installation requirements for fixed industrial process heating employing electric resistance or electrode heating technology.
- Article 691 Large-Scale Photovoltaic (PV) Electric Supply Stations - new article addresses requirements for large scale PV systems of no less than 5000 kW that are used to deliver power back to the utility grid.
- Article 706 Energy Storage Systems - new article addresses installation requirements for energy storage systems. The current state of energy storage technology, which includes batteries, and the anticipated evolution of energy storage support the need for a singular set of requirements in NFPA 70 covering such systems.
- Article 710 Standalone Systems - New article addresses requirements for electric power production sources operating in a stand-alone mode independent of an electrical production and distribution network.
- Article 712 Direct-Current Micro-grids - New requirements to address micro-grids as they are becoming popular and are a means to increase energy efficiency, reduce costs, and maintain critical business continuity. Powering utilization equipment directly from dc sources without intervening dc-ac and ac-dc conversion steps, leads to higher efficiencies and potentially smaller and lower-cost equipment than ac-coupled methods.
- Revised requirements covering the expanding use of solar photovoltaic power, to further increase first responder safety performing operations on a roof by establishing a boundary creating two areas of rapid shutdown protection, to provide separate requirements for protection inside and outside of the boundary, and to specify performance requirements for the rapid shutdown equipment inside and outside the boundary.
- Revised requirements to include wireless charging technology installation requirements for electrical vehicles.

Examples of new and revised requirements that may provide relief on the overall cost of the electrical system.

- New exception for bank and office occupancies permitting reduction of lighting load based on allowable load density prescribed by adopted energy codes. This may grant substantial relief for sizing of service and feeder distribution systems.
- Deletion of Table 310.15(B)(3)(c). This removes the required temperature adder for ambient temperature adjustment correction when calculating conductor size for

conductors installed on rooftops exposed to sunlight unless conductors are installed 7/8" or closer to the roof.

- 310.15(B)(7). Expansion of use of 83% reduction for 3-conductor (2 hots and a neutral) feeders derived from either single or three phase supplies.
- 338.10(B)(4) Revised to only require cables with 10 AWG and smaller conductors to default to the 60 degree C ampacity where installed in insulation.
- New language covering any of the GFCI requirements involving a measurement to determine receptacle proximity.
- Revision to permit any appliance installed in rooms or areas required to be supplied by a 20 ampere small appliance branch circuit to be supplied from an individual branch circuit rated 15 amperes or greater.
- Revisions to only require a receptacle for service equipment located indoors and new exception for services rated more than 120 volts to ground that supply certain types of equipment.

Protecting electrical workers while maintaining or servicing electrical or electrically-powered equipment.

- Revision to require additional marking requirements for non-dwelling unit service equipment rated 1200 amperes or more.
- New requirements that include working space for equipment located in a space that has limited access.
- Revised requirements for arc energy reduction provide additional methods for acceptable arc flash mitigation methods and provide arc energy reduction requirements for fuses rated 1200 amperes or greater.
- New requirements for marking equipment with the short circuit current and maximum available fault current for elevators, industrial machinery and industrial control panels.
- New requirements for electronic lighting control switches prohibiting the introduction of current on the equipment grounding conductor during normal operation.
- New provision that requires barriers for panelboards to provide some measure of safety against inadvertent contact with line-energized parts during maintenance and installation of new feeders or branch circuits.
- New requirement for surge protection for industrial machinery and fire pump controllers.

Protecting hotels and motels from fires of electrical origin

- Arc-fault circuit interrupters are the most advanced technology currently recognized by NFPA 70 for protecting premises against fires resulting from damaged wiring. Revisions to these requirements expand this protection to these occupancies.

Protecting people from electric shock in homes, workplaces and places of recreation.

- New requirements for ground-fault circuit interrupter protection (GFCI) expand the protection across a range of uses and occupancies. First introduced in the early 1970s, their continued expansion to cover areas in homes and workplaces where occupants are particularly susceptible to electric shock accidents can be directly attributed to reductions

in electrocutions and electric shock accidents.

- Revision to add boatyards and commercial and noncommercial docking facilities to the scope of Article 555 and lowering the ground-fault protection threshold to a maximum 30 mA.
- New series of requirements covering the certification, marking, protection, and field installation of “electrically powered pool lifts.”

Updating NFPA 70 makes sure communities continue to provide an acceptable level of public safety while supporting the latest technological advances, which is core to the mission of the OBBS.

This petition is submitted on behalf of the Ohio Electrical Coalition, which is comprised of a broad cross section of industry stakeholders committed to moving electrical safety forward in the State of Ohio through timely adoption of the 2017 edition of NFPA 70. This will ensure that there are safe installation requirements in place to allow uniform implementation of the latest developments in electrical systems, equipment, and technology to meet consumer demand.

Sincerely,

Ohio Electrical Coalition

9/7/16

Regina Henshaw, Executive Secretary
Board of Building Standards
6606 Tussing Rd.
PO Box 4009
Reynoldsburg, OH 43068-9009

RE: 2017 National Electrical Code Adoption

Dear Regina,

The Independent Electrical Contractors of Greater Cincinnati request for a rule change to update the 2014 National Electrical Code (NEC) to the 2017 edition in accordance with ORC 3781.12

The 2017 NEC provides numerous changes that will enhance public safety. Included are new articles to address technology such as direct current micro grids, large solar photovoltaic arrays and energy storage systems that are being installed in Ohio. The installation rules for these systems are not addressed in the 2014 NEC and are necessary for installers as well as Ohio Electrical Safety Inspectors and first responders.

Lighting technology has changed the way buildings and roadways are illuminated that save taxpayers and homeowners money. There are revisions to calculating general lighting loads in banks and office buildings to recognize energy saving lighting that will reduce the overall size of the electrical service and lower the costs of new and remodeled building projects across the state.

I have served as Principal on the NEC Code making Panel 1 since 1999 and the National Fire Protection Association (NFPA) NEC Correlating Committee since 2006. The NEC is the most widely adopted consensus Code in the world. Consensus is a key word when developing the document. The NFPA provides the document rules and governing procedures that stipulate all NEC changes have had public input and public review. Technical committee membership classifications are used to maintain balanced Code Making Panels that represent their Principal interest to ensure changes are necessary and in the best interest of public safety.

I urge the state of Ohio to adopt the 2017 without delay or modifications to the document.

Sincerely,

David Hittinger
Executive Director



National Fire Protection Association

Tim McClintock
Regional Electrical Code Specialist
11813 Township Road, Shreve, Ohio, 44676, USA
TEL: +1 330-567-2030 CELL: +1 330-749-9782 Email: tmccclintock@nfpfa.org

October 25, 2016

Ms. Regina Hanshaw
Executive Secretary
Ohio Board of Building Standards
6606 Tussing Rd
Reynoldsburg, OH 43068

Re: Support for the Ohio Electrical Coalition's Petition to Update Referenced Standard NFPA 70

Dear Ms. Hanshaw:

NFPA 70 focuses on the proper installation of electrical systems and equipment to protect people and property from hazards arising from the use of electricity. As electrical equipment has become more complex and widespread, the NFPA 70 has adapted to meet new challenges. Revised every three years to allow for new technologies and improved installation safety practices, NFPA 70 is a ready-to-use, comprehensive standard suitable for adoption.

NFPA 70 is developed and produced by the National Fire Protection Association (NFPA), an independent, not-for-profit standards developing organization and advocate of fire, building, and electrical safety. Since 1911, NFPA has been the sponsor of NFPA 70 and the requirements of this standard have continued to evolve with America's heavy reliance on reliable and safe electrical energy. NFPA 70 is developed through an open, transparent, and balanced process accredited by the American National Standards Institute.

The NFPA 70 community has worked diligently to make sure safe installation rules are in place for the continuously changing electrical industry landscape. The 2017 edition of NFPA 70 was issued by the NFPA Standards Council on August 4, 2016 and was approved as an American National Standard on August 24, 2016.

In addition to advancement of new methods and installation practices, new requirements for utility-scale PV systems, direct-current microgrids and energy storage systems are included in the 2017 NFPA 70 and are examples of the regulatory piece trying to keep up with the innovation piece.

These are exciting times for the electrical industry as we transition from centralized utility supplied electricity to on-site generation, distribution and storage. Timely adoption of the 2017 NFPA 70 will ensure we don't hamstring innovators, installers and most importantly the regulators with respect to advancements in technology and innovation.

NFPA supports the petition filed on behalf of the Ohio Electrical Coalition, to update the 2014 edition of NFPA 70 to the 2017 edition and encourages the Ohio Board of Building Standards to

move forward by providing its citizens with the appropriate level of safety outlined in the 2017 edition of NFPA 70.

Sincerely,

A handwritten signature in black ink that reads "Tim McClintock". The signature is written in a cursive style with a large initial "T" and a stylized "M".

Tim McClintock
Regional Electrical Code Specialist
National Fire Protection Association
Office: 330-567-2030
Cell: 330-749-9782
tmcclintock@nfpa.org



"Let the Code Decide"
OHIO CHAPTER
International Association of
Electrical Inspectors

President

Cathryn Robinson
Southwest Division

First Vice-President

Calvin Beverly
Akron Division

Second Vice-President

Michael Koken
Eastern Division

Immediate Past-President

lerald Gerber
Western Reserve Division

Secretary/Treasurer

Lorenzo Adam
Southwest Division

Inspector Member

Karl Frederick
Central Division

Inspector Member

Zach Jenkins
Northwest Division

Inspector Member

Kenneth Bolyard
West Virginia Division

Inspector Member

Joseph Cenzori
Western Reserve Division

Associate Member

Ronald F. Schapp
Southwest Division

Western Section

Chapter Representative
Jeff Grassi
Western Reserve Division

Membership Chairman

Joseph Cenzori
Western Reserve Division

Education Chairman

Gaylord Poe
Southwest Division

Historian

Kenneth Bolyard
West Virginia Division

October 18, 2016

Ohio Board of Building Standards
6606 Tussing Road.
Reynoldsburg, Ohio 43068
Attention: Regina Hanshaw, Executive Secretary

RE: 2017 NEC Adoption

Dear Regina Hanshaw and Ohio Board of Building Standards,

I am writing this letter on behalf of the Ohio Chapter IAEI. The Ohio Chapter IAEI is in complete support of the quick and timely adoption of the NEC 2017 Edition. Electrical safety for Ohio citizens is paramount and the quick and timely adoption of the NEC 2017 Edition will aid in the electrical safety for all Ohio citizens.

Technology is forever advancing and this new technology is being installed in homes and buildings all over this State. Our Standards of electrical safety for installations and inspections should keep up with this ever changing technology to ensure the electrical safety for the citizens of Ohio in their homes and all buildings that they enter.

The NFPA works diligently to create a new Edition every three years. This is a collaborate effort with electrical industry manufacturers, national recognized testing labs like UL, design professionals, inspectors and installers from all over the country. These are the groups and individuals that know the electrical industry inside and out. All of these groups and individuals work for the betterment of electrical safety and through the NEC 2017 Edition has created a Standard that will offer the safest electrical installation to date.

It may be the opinion of some on the OBBS that this new standard is not needed at this time but it is the opinion of the Ohio Chapter IAEI Board, its members statewide, and the Ohio electrical industry that it is gravely needed and needed in a quick and timely manner. It is needed to ensure the greatest level of safety of all Ohio Citizens.

Thank You,

Caty Robinson
President
Ohio Chapter IAEI



KYLE PITSOR

Vice President, Government Relations

October 4, 2016

Ms. Regina Hanshaw
Executive Secretary
Ohio Board of Building Standards
6606 Tussing Road
Reynoldsburg, OH 43068

Re: NEMA Supports Adoption of 2017 Edition of the National Electrical Code

Dear Ms. Hanshaw:

On behalf of the National Electrical Manufacturers Association (NEMA), I am writing to express support to update the 2014 edition of NFPA 70 (National Electrical Code®) to the 2017 edition of NFPA 70. For many years, Ohio has championed the standard of excellence by being one of the first states in the nation to adopt the newest edition of the National Electrical Code® – putting the safety of its citizens and economic well-being of its industry first.

NEMA is the trade association of choice for the electrical equipment and medical imaging manufacturing industry. The approximately 400 member companies manufacture products used in the generation, transmission and distribution, control, and end-use of electricity. NEMA member companies have a significant presence in the state of Ohio representing 27 companies with 145 manufacturing and engineering facilities that support the state's economy. Member companies in Ohio collectively employ over 21,357 state residents.

NEMA has long supported timely adoption of the National Electrical Code® (NEC) by state and local jurisdictions. We maintain that prompt adoption of the most current edition of the NEC is the best way to ensure a uniform and up-to-date standard of safety for all occupants in the built environment. Current codes mean safer and more economically prosperous communities.

The NEC focuses on the proper installation of electrical systems and equipment to protect people and property from hazards arising from the use of electricity in the built environment. The code also allows for the safe use of new technologies including electric vehicle charging equipment and distributed generation such as solar photovoltaic panels.

Through adoption of the 2017 NEC, businesses today will be able to take advantage of lower infrastructure start-up and operational costs through new and improved technology. For instance, Article 691 Large-Scale Photovoltaic (PV) Electric Supply Stations - addresses requirements for large scale PV systems of no less than 5000 kW. Article 712 Direct-Current Micro-grids - New requirements to address micro-grids as they are becoming popular and are a means to increase energy efficiency, reduce costs, and maintain critical business continuity.

National Electrical Manufacturers Association
1300 North 17th Street, Suite 900 - Rosslyn, VA 22209

Ms. Regina Hanshaw
March 14, 2014
Page 2

Once again, NEMA urges the OBBS to maintain this tradition of excellence by adopting the 2017 edition of the National Electrical Code®. If you have any questions, please contact Don Iverson (don.iverson@nema.org) or 517-628-2505.

Sincerely,

A handwritten signature in black ink that reads "Kyle Pitsor". The signature is written in a cursive, flowing style.

Kyle Pitsor
Vice President, Government Relations



Southwest Division

Ohio Chapter, Western Section, I.A.E.I.

International Association of Electrical Inspectors

<http://www.swohioiaei.org/>

Board of Directors

Gaylord Poe, President
Inspection Bureau, Inc.
250 W. Court St.
Cincinnati, Ohio 45202
Phone: (513) 977-4394
Fax: (513) 381-6123
E-mail: gpoe@inspectionbureau.com

Dewayne Jenkins, 1st V.P.
City of Kettering
3600 Shroyer Rd.
Kettering, Ohio 45429
Phone: (937) 296-2419
Fax: (937) 296-3240
E-Mail:
Dewayne.jenkins@ketteringoh.org

Pete Baldauf, Legislation
City of Vandalia
3887 Reinwood Dr.
Dayton, Ohio 45414
Phone: (937) 415-2326
Fax: (937) 415-2319
E-Mail: PBaldauf@ci.vandalia.oh.us

Lorenzo Adam, Secretary
City of Mason
6000 Mason-Montgomery Rd.
Mason, Ohio 45040
Phone: (513) 229-8520
Fax: (513) 229-8521
E-Mail: ladam@maszonoh.org

Ken Dunning – Treasurer
10177 Zig Zag Rd.
Cincinnati, Ohio 45242
Phone: (513) 984-3963
Fax: (513) 984-1232
E-Mail: csnkid@coconorwin.com

Active Inspector Members

Caty Robinson
Inspection Bureau, Inc.
250 W. Court St.
Cincinnati, Ohio 45202
Phone: (513) 977-4394
Fax: (513) 381-6123
E-Mail:
Crobinson@inspectionbureau.com

John Keller
Ohio Department of
Rehabilitation & Correction
Phone: (937) 372-0797
E-Mail: johnskel@aol.com

Associate Member

Ken Carr
Carr Electric Co.
Phone: (513) 574-3733
E-Mail: ken@carr-electric.com

10/11/16

Regina Hanshaw
Ohio Board of Building Standards
6606 Tussing Rd.
P.O. Box 4009
Reynoldsburg, OH 43068-9009

RE: 2017 NEC

Dear Ms. Hanshaw,

The SW Division IAEI, representing 19 southwest Ohio counties, fully supports the proposals initiating Ohio's adoption of the 2017 NEC outlined in the proposed sections for update in all three codes:

4101:1-35-01 Referenced standards: ~~70-14 National Electrical Code~~ 70-17 National Electrical Code (Ohio Building Code)

4101:2-15-01 Referenced standards: ~~70-14 National Electrical Code~~ 70-17 National Electrical Code (Ohio Mechanical Code)

4101:3-13-01 Referenced standards: ~~70-14 National Electrical Code~~ 70-17 National Electrical Code (Ohio Plumbing Code)

preferably on January 1st, 2017.

It is a fact that the electrical industry is constantly changing and growing and will continue to do so at a rapid pace. With or without Ohio's adoption of the 2017 NEC, manufacturers, vendors, designers and installers will continue to employ the very latest and best in electrical technology.

Without adoption of the most up to date edition of the NEC, electrical inspectors cannot address many of these emerging technologies. Without adoption of the most up to date edition of the NEC, property owners cannot benefit from rule changes that often reduce cost and provide other benefits. When electrical inspectors cannot use the most current Standard for their inspections the public safety suffers.

Late adoption is a relatively new problem in Ohio, a problem that is getting worse instead of better. In recent years electrical inspectors have been tasked with

enforcing two editions of the NEC for a significant portion of a given code cycle – one edition being applied to OBC work and another edition being applied to RCO work.

There have been many projects where a builder is building 3-family dwellings beside 4-family dwellings; with the 3-family dwelling and the 4-family dwelling each subject to different editions of the NEC!

Unfortunately, the buildings where most Ohioans sleep (*trusting that the very latest and best in code adoption and enforcement is protecting their family*) – 1, 2, and 3-family dwellings - are usually the last in line to benefit from timely adoption of the NEC because of the intense lobbying that goes on to delay code adoption. Special interests - HBA is an excellent example - secure appointments to boards and committees that regulate building code adoption. The current process is for the appointees to wait until the exhaustive technical processes of the NEC code panels are completed before they stop adoption with political power. We have seen firsthand where the value of NFPA's exhaustive technical process is totally ignored by a board top-heavy with outside interests. What follows is either a delay in adoption or worse: portions of the NEC deleted or modified by these "experts". The special interests are the "winners". The public safety is the "loser". There is serious change needed in the code adoption process.

There was a time not too many years ago when Ohio led the way in electrical safety by adopting the most current edition of the NEC for ALL occupancies, usually in January of the year it was released. The OBBS fails the public safety when it helps to delay instead of promote timely adoption of the NEC. Special interest groups and financial interests appear to have the "ear" of the Board more than ever before and public safety suffers every day that adoption is delayed.

We encourage you to promote electrical safety for all Ohioans by returning to the methods employed in the past that enabled timely adoption of the latest edition of the NEC for use as the referenced standard in the OBC and RCO.

Very truly yours,

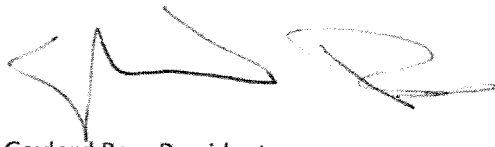
A handwritten signature in black ink, appearing to read 'Gaylord Poe', with a stylized flourish at the end.

Gaylord Poe, President

We are witnesses to a revolutionary expansion and change to the electrical industry as we transition from 'centralized utility supplied' electricity to on-site generation, distribution and storage. Timely adoption of the 2017 NEC will ensure we do not restrict innovators, installers and most importantly the regulators in respect to newer technology and advancement. The 2017 NEC introduces new methods and installation practices for safely distributing electrical power, safe interaction with electrical systems, and addresses safety concerns not previously covered in the current standard and furthers the fire and shock prevention mission of the code. Updating to the 2017 NEC is a vitally important and a proactive step for the economic savings, consumer protection and the safety advancements of new electric system technology. Delaying implementation has become a trend in the adoption process that subjects the electrical and building industries to standards and codes that have not kept pace with changes to energy efficiency and conservation, safety, training, innovation and the new technologies.

The citizens of Ohio deserve and expect the best that is offered for their homes, occupations, places we work at, worship at, play and entertain. The intent of the National Electrical Code is the 'practical safeguarding of persons and property from the hazards arising from the use of electricity'. All of the changes and new technology that we are witnessing require proper installation and safety requirements found in the most current code. They need to be adopted and utilized for the protection of the public. We need to do all that we can to accomplish that.

Respectfully submitted,

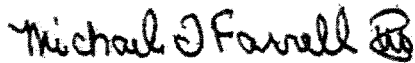

Michael J. Farrell III

Building/Electrical Inspector

Lucas County Building Regulation

Member of IA EI, IBEW, ICC, NFPA, OBOA

NEC Code Making Panel 3

NFPA 790/791 (EEE)

Secretary/Treasurer

Northwest Division

OHIO Chapter IA EI



727 Lime City Road, Suite 100 Rossford, OH 43460

October 20, 2016

Ohio Board of Building Standards
6606 Tussing Rd.
Reynoldsburg, OH 43068

Attn: Regina Henshaw, Executive Director

Dear Regina Henshaw and esteemed members of the Board,

The Ohio/Michigan Chapter of NECA Board of Directors have asked me to draft this letter of recommendation on our Chapters behalf regarding the following:

RE: 4101:1-35-01 Referenced standards: ~~70-14 National Electrical Code~~ 70-17 National Electrical Code (Ohio Building Code)

4101:2-15-01 Referenced standards: ~~70-14 National Electrical Code~~ 70-17 National Electrical Code (Ohio Mechanical Code)

4101:3-13-01 Referenced standards: ~~70-14 National Electrical Code~~ 70-17 National Electrical Code (Ohio Plumbing Code)

We support the changes to the Ohio Building Code incorporating NFPA 70- 2017 Edition of the National Electrical Code as proposed by the petition submitted by the Ohio Electrical Code Coalition.

Timely adoption of the new NEC Code changes will help promote safety for installers and customers. It also helps the state of Ohio keep pace with changes in technology and safety enhancements. New requirements have been added to help communities accomplish the goal of making buildings safer, energy efficient, and reliable in the event of emergencies or disasters. Advancement of technology requires up to-date standards for safe implementation, to ensure that the end-user can take advantage of this innovation without endangering themselves, others, or their property.

Revised requirements covering the expanding use of solar photovoltaic power, to further increase first responder safety performing operations on a roof and to specify performance requirements for rapid shutdown protections. This is vital for our firefighting community and an area that they are fully in support of seeing implemented.

These are exciting and changing times for the electrical industry as we transition from centralized utility supplied electricity to on-site generation, distribution and storage. Timely adoption of the 2017 NEC will ensure we do not restrict

innovators, installers and most importantly, the regulators in respect to newer technology and innovation. The 2017 NEC advances new methods and installation practices for safely distributing electrical power, safe interaction with electrical systems, to address safety concerns not previously covered in the current standard and furthers the fire and shock prevention mission of the code. Updating to the 2017 NEC is a vitally important and proactive step for the economic savings, consumer protection and the safety advancements of new electrical system technology. Delaying implementation has become a trend in the adoption process that subjects the electrical and building industries to standards and codes which have not kept pace with changes to energy efficiency and conservation, safety, training, innovation and new technologies.

The citizens of Ohio deserve and expect the best that is offered for their homes, occupations, places we work at, worship at, play and entertain. The intent of the National Electrical Code is the 'practical safeguarding of persons and property from the hazards arising from the use of electricity'. All of the changes and new technology that we are witnessing require proper installation and safety requirements found in the most current code. They need to be adopted and utilized for the protection of the public.

Sincerely,

A handwritten signature in black ink, appearing to read 'Todd Michaelsen', with a stylized flourish extending to the right.

Todd Michaelsen, Chapter Manager
Ohio/Michigan Chapter NECA



Powering Business Worldwide

Christopher D. Hess
Director
Public Affairs
1000 Eaton Boulevard
Cleveland, OH 44256
(440)523-4198

October 25, 2016

Ms. Regina Hanshaw
Executive Secretary
Ohio Board of Building Standards
6606 Tussing Road
Reynoldsburg, OH 43068

Re: Eaton Supports Ohio Electrical Coalition Petition to update the 2014 edition of the National Fire Protection Association (NFPA) 70 with the 2017 edition of NFPA 70.

Dear Ms. Hanshaw:

I am writing to express Eaton's support of the State of Ohio to update the 2014 edition of NFPA 70 with the 2017 edition of NFPA 70.

Eaton employs over 2500 people at 11 locations in the State of Ohio and spends over \$420 million with Ohio based businesses every year. Eaton's electrical business is a global leader with expertise in power distribution and circuit protection; backup power protection; control and automation; lighting and security; structural solutions and wiring devices; solutions for harsh and hazardous environments; and engineering services.

For many years, Ohio has championed the standard of excellence by being one of the first states in the nation to adopt the newest edition of the National Electrical Code® – putting the safety of its citizens and economic well-being of its industry first. Updating NFPA 70 makes sure communities continue to provide an acceptable level of public safety while supporting the latest technological advances, which is core to the Ohio Board of Building Standards (OBBS) mission.

Eaton has long supported timely and un-amended adoption of the National Electrical Code® (NEC) by state and local jurisdictions. We believe that adoption of the most current edition of the NEC promotes a uniform and up-to-date standard of safety for all occupants in the built environment. Current codes produce safer and more economically prosperous communities.

Once again, Eaton urges the OBBS to maintain this tradition of excellence by adopting the 2017 edition of NFPA 70.

If you have any questions, please contact me at (440) 523-4198. Thank you for your time and consideration of this important matter.

Sincerely,

Christopher D. Hess
Director, Public Affairs



LOCAL UNION No. 8

INTERNATIONAL BROTHERHOOD OF ELECTRICAL WORKERS

807 Lime City Road • Rossford, Ohio 43460
Phone 419-666-8920 • Fax 419-666-3984 • Website www.ibew8.org

Roy B. Grosswiler, *Business Manager* • Eric E. Grosswiler, *President* • Gregory D. Hammer, *Recording Secretary*

October 19, 2016

Ohio Board of Building Standards
6606 Tussing Rd.
Reynoldsburg, OH 43068

Regina Henshaw, Executive Director and esteemed members of the Board.

RE: 4101:1-35-01 Referenced standards: 70-17 National Electrical Code (Ohio Building Code)

4101:2-15-01 Referenced standards: 70-17 National Electrical Code (Ohio Mechanical Code)

4101:3-13-01 Referenced standards: 70-17 National Electrical Code (Ohio Plumbing Code)

As the Business Manager of IBEW Local #8 representing over 2,000 members in the Electrical Construction Trade, in various construction and maintenance projects under commercial, residential, low voltage, solar, wind and manufacturing, I support the changes to the Ohio Building Code incorporating NFPA 70-2017 edition of the Ohio Electrical Code Coalition and its members including: NFPA, NECA, NEMA, IBEW, IAEI, NACMA, UL, IRC, ESFi, EEI and many other stakeholders. Updating to the 2017 NEC is a vitally important and proactive step for consumer protection and for the safe advancement of new electrical system technology. This unified approach to a timely adoption of the most current and up to date codes and standards should emphasize the importance of putting safety ahead of any cost concerns.

Using and referencing the most current codes and standards is necessary for a progressive state and its citizens to keep pace with changes to technology and safety enhancements. New requirements have been added, to protect electrical workers while maintaining and servicing electrical or electrically powered equipment. These new requirements are very important safe guards that protect from inadvertent contact with line-energized parts during maintenance and installation of new feeders or branch circuits.

The safety of my members is number one. The new changes in working space for equipment located in a space that has limited access, the marking of equipment with the short circuit current and maximum available fault current for elevators, industrial machinery and control panels are some of the key changes that protect electrical workers.

Protecting people from electric shock in their homes, workplaces and places of recreation are very important as well. We have come a long way since the early 1970's in the requirements for ground fault circuit interrupter (GFCI) that expand the protection across a range of uses and occupancies. I believe the continued expansion to cover areas in homes and workplaces where occupants are particularly susceptible to electric shock accidents can be directly attributed to reductions in electrocutions and electric shock accidents.



LOCAL UNION No. 8

INTERNATIONAL BROTHERHOOD OF ELECTRICAL WORKERS

As technology changes so does the need for new ways of electrical energy such as utility-scale PV systems. These are exciting times for the electrical industry as we transition from centralized utility supplied electricity to on-site generation, distribution and storage.

Timely adoption of the 2017 NEC will ensure we don't restrict innovators, installers, and most importantly the regulators in respect to newer technology and innovation. The 2017 NEC advances new methods and installation practices for safely distributing electrical power, safe interaction with electrical systems, to address safety concerns not previously covered in the current standards and furthers the fire and shock prevention mission of the code. Updating to the 2017 NEC is a vitally important and proactive step for consumer protection and for the safe advancement of new electrical system technology.

I'm a 31 year member of Local #8 and now honored to be the Business Manager of this great organization. I worked in the field as a Journeyman Electrician and have seen many changes throughout these years. The intent of the National Electrical Code is the practical safe guarding of persons and property from hazards arising from the use of electricity. All of the changes have made safer conditions for proper installation and protection for electrical workers. They need to be adopted and utilized for the protection of the public and for the electrical workers. Thank you for your consideration to accomplish that.

Respectfully submitted,

A handwritten signature in cursive script that reads "Roy B. Grosswiler".

Roy B. Grosswiler
Journeyman Wireman
Business Manager of IBEW Local #8



October 25, 2016

Ms. Regina Hanshaw
Executive Secretary
Ohio Board of Building Standards
6606 Tussing Road
Reynoldsburg, OH 43068

Re: Schneider Electric Supports the Ohio Electrical Coalition Petition to Update Referenced Standard (NFPA 70) National Electrical Code® 2014 Edition to the 2017 Edition

Dear Ms. Hanshaw:

I am writing to inform you of Schneider Electric's **support of the Ohio Electrical Coalition Petition to update the National Electrical Code from the 2014 NEC to the 2017 NEC.**

Schneider Electric is a global energy management specialist that operates in the fields of industry, energy, power, and healthcare, and provides infrastructure solutions for cities and states. As part of a major presence in the United States, in Ohio we have over 650 employees at 14 different locations including 4 manufacturing facilities. We also support thousands of additional direct and indirect jobs in Ohio by working with hundreds of vendors and suppliers located in the state.

Schneider Electric continues to advocate for timely adoption of the National Electrical Code® (NEC). The NEC focuses on the proper installation of electrical systems and equipment supporting safe electrical infrastructure installations which also establishes the safe use of electricity. Our products are designed and manufactured to comply with the most current edition of the National Electrical Code. Supporting design and construction of electrical infrastructure that does not utilize the most current electrical code restricting the use of the most current technology and designs is less efficient and more costly for not only Schneider Electric to manufacture, but also for the engineering and the construction industry to implement.

The adoption of the 2017 NEC will permit business to take advantage of more cost effective infrastructure investment and operational costs through technological advancements.

Once again, Schneider Electric urges the OBBS to promptly initiating the review and adoption of the 2017 NEC.

Sincerely,

A handwritten signature in cursive script that reads "Alan Manche".

Alan Manche

Vice President, External Affairs

Cc: John Nomina – Plant Manager - Oxford, OH Facility
John Blaylock – Vice President Service Operations – West Chester, OH

Monday, October 24, 2016

Ohio Board of Building Standards Regina Hanshaw, Executive Secretary
6606 Tussing Road Reynoldsburg, Ohio

Dear Board Members,



The Ohio Electrical Training Directors Association is an organization representing the Directors of all nineteen IBEW/NECA electrical apprenticeship and training programs across Ohio. OETDA training programs are recognized for excellence, most recently by the Ohio Board of Regents and the Higher Learning Commission who have granted these programs a statewide articulation agreement providing portable college credit to IBEW/NECA apprenticeship completers. Statewide these programs invest tens of millions of private dollars to assure Ohio has a pool of highly trained electrical professionals.

We are writing today in support of the Ohio Electrical Code Coalition's petition requesting the adoption of the 2017 edition of NFPA 70. This adoption is important for Ohio's many registered apprenticeship programs, as we bare the unique responsibility of providing up to date technological instruction on new electrical systems and apparatus to Ohio's professional electrical installation workforce. The 2017 edition of NFPA 70 has many new articles defining safe installation requirements for such installations such as large scale photovoltaic supply stations, Stand Alone Power Generation Systems, Direct Current Microgrids and most importantly Energy Storage Systems. It is impossible to provide meaningful instruction on these cutting edge systems without adopted electrical safety installation codes. Ohio businesses cannot install these cutting edge systems without an installation code in place, and a well training workforce.

Additionally, OETDA training programs spend a good portion of their budgets safety training apprentices and providing continuous safety instruction to journeymen. The 2017 edition of NFPA 70 contains several important revisions designed to enhance electrical worker safety. The adoption of the document would reassure Ohioans are safer on the job.

In summation, the OETDA urges the Ohio Board of Building Standards to adopt the 2017 NFPA 70 document. It's the right thing to do to keep Ohio workers safe and Ohio at the forefront of technology.

Sincerely Yours,

Stephen Lipster, Secretary - Treasurer



October 21, 2016

Ohio Board of Building Standards
Regina Hanshaw, Executive Secretary
6606 Tussing Road
Reynoldsburg, OH 43066

Subject: Petition to update the referenced National Electrical
Code 2014 edition to the 2017 edition

Dear Secretary Hanshaw,

We at Underwriters Laboratories (UL) are deeply committed to advancing the safety of the citizens of the state of Ohio. UL believes NFPA 70, the National Electrical Code (NEC) serves as an important tool in advancing that safety. Continued adoption of the 2017 NEC by the Ohio Board of Building Standards is critical to these efforts. Pursuant to the Ohio revised Code 3781.12, UL is writing to request that the State of Ohio move forward with the adoption of 2017 NFPA 70 NEC as requested in the petition filed by the Ohio Electrical Coalition. Adoption will ensure enforcement of the latest advancement of electrical safety requirements.

Dedicated effort is put into updating new versions of the NEC for purposes of adopting the most current best practices for electrical safety. Timely adoption of the 2017 NEC will ensure public safety is not compromised. In order to improve code application and enforcement throughout the State and to reap the advantages of new standards and technology that enhance electrical safety, we encourage the Ohio Board of Building Standards to adopt the 2017 NEC.

In conclusion, neither the safety of Ohio State's citizens nor its electrical industry would benefit from a delay in the adoption of the latest electrical code, leaving the state stalled with the 2014 NEC. Instead, the Ohio Board of Building Standards should take advantage of new safety requirements that have been written in the latest edition of the NEC.

Sincerely,

A handwritten signature in cursive script that reads "Barbara R. Guthrie".

Barbara R. Guthrie
Vice President and Chief Public Safety Officer
Underwriters Laboratories Inc.

Contact Information:
Office: 847.664.3308
Email: Barbara.R.Guthrie@ul.com

cc: Tom Lichtenstein
Senior Regulatory Engineer